

# 475

## FIELD COMMUNICATOR

**Test Equipment Depot**  
1-800-517-8431

99 Washington Street  
Melrose, MA 02176  
Phone 781-665-1400  
Toll Free 1-800-517-8431

Visit us at [www.TestEquipmentDepot.com](http://www.TestEquipmentDepot.com)

## USER'S MANUAL



## 475 Field Communicator

### NOTICE

Read this User's Manual before working with the 475 Field Communicator. For personal and system safety, and for optimum product performance, thoroughly understand the contents before using or servicing this product.

For equipment service needs, contact the nearest product representative.

©2009 Emerson Process Management. All rights reserved.

*The Emerson logo is a trademark and service mark of Emerson Electric Co.*

*AMS Suite is a registered trademark of Emerson Electric Co.*

*Rosemount and SMART FAMILY are registered trademarks of Rosemount Inc.*

*Windows is a registered trademark of Microsoft Corporation in the United States and other countries.*

*IrDA is a registered trademark of the Infrared Data Association.*

*Bluetooth is a registered trademark of the Bluetooth SIG, Inc.*

*FOUNDATION is a trademark of the Fieldbus Foundation.*

*HART is a registered trademark of the HART Communication Foundation.*

*Hitachi is a registered trademark of Hitachi America, Ltd.*

*All other marks are the property of their respective owners.*

*U.S. and foreign patent numbers are pending.*

---

# TABLE OF CONTENTS

## SECTION 1 Introduction

Using this Manual . . . . .	1-1
-----------------------------	-----

## SECTION 2 Learning the Basics

<b>Overview . . . . .</b>	<b>2-1</b>
<b>Safety Messages . . . . .</b>	<b>2-1</b>
<b>475 Field Communicator Overview . . . . .</b>	<b>2-2</b>
Device Interoperability . . . . .	2-2
Working in a Hazardous Area . . . . .	2-2
Battery and Power Supply/Charger . . . . .	2-3
Using the Touch Screen . . . . .	2-7
Using the Keypad . . . . .	2-7
Memory . . . . .	2-8
Accessories . . . . .	2-9
<b>Assembly . . . . .</b>	<b>2-10</b>
Installing the System Card and the Battery . . . . .	2-10
Removing the Battery and the System Card . . . . .	2-11
<b>Starting Up and Shutting Down . . . . .</b>	<b>2-11</b>
Starting Up . . . . .	2-11
The Field Communicator Main Menu . . . . .	2-11
Entering Standby . . . . .	2-12
Shutting Down . . . . .	2-12
<b>Settings . . . . .</b>	<b>2-12</b>
About Field Communicator . . . . .	2-12
Backlight . . . . .	2-12
Clock . . . . .	2-13
Contrast . . . . .	2-13
License . . . . .	2-13
Memory . . . . .	2-13
Power Status . . . . .	2-14
Retrain The Battery . . . . .	2-14
Touch Screen Alignment . . . . .	2-14
Event Capture . . . . .	2-15
Exit to Main Menu . . . . .	2-15
<b>Connecting to a Device . . . . .</b>	<b>2-15</b>
<b>PC Applications . . . . .</b>	<b>2-16</b>
AMS Device Manager . . . . .	2-16
Field Communicator Easy Upgrade Utility . . . . .	2-16
Connecting the 475 Field Communicator or System Card . . . . .	2-17
Upgrading the 475 Field Communicator . . . . .	2-19
Adding Functionality by Enabling Licenses . . . . .	2-20
<b>ScratchPad . . . . .</b>	<b>2-21</b>
Creating a New Document . . . . .	2-21
Opening an Existing Document . . . . .	2-21
<b>Maintenance . . . . .</b>	<b>2-23</b>
Running a Self Test . . . . .	2-23
Calibrating . . . . .	2-23

---

**SECTION 3  
HART Functionality**

**Overview** ..... 3-1

**Safety Messages** ..... 3-1

**Basic Features and Functions** ..... 3-2

    HART Application Functionality ..... 3-2

    Using a Fast Key Sequence ..... 3-2

**Starting the HART Application** ..... 3-2

**Working with Offline Configurations** ..... 3-3

    Creating a New Configuration ..... 3-3

    Opening a Saved Configuration ..... 3-4

    Transferring Configurations to a PC Application ..... 3-6

**Working Online with HART Devices** ..... 3-6

    Connecting to a HART Device ..... 3-6

    Displaying the Connected HART Devices ..... 3-9

    Interpreting the HART Icon ..... 3-10

    Saving a Device Configuration ..... 3-10

    Displaying Device Setup Options ..... 3-11

    Displaying Graphics ..... 3-12

**Configuring the HART Application** ..... 3-13

    Using Hot Keys ..... 3-13

    Changing the HART Polling Options ..... 3-15

    Ignoring Status Messages ..... 3-16

    Changing the Menu Title for HART Revision 6 or Higher Devices ..... 3-16

    Storage Cleanup ..... 3-16

    Viewing Available Device Descriptions ..... 3-17

    Simulating an Online Connection to a HART Device ..... 3-17

**Running HART Diagnostics** ..... 3-18

    DC Voltage Measurement (HART Terminals) ..... 3-18

**Disconnecting from a HART Device** ..... 3-18

**SECTION 4  
Fieldbus Functionality**

**Overview** ..... 4-1

**Safety Messages** ..... 4-1

**Basic Features and Functions** ..... 4-2

    Fieldbus Application Functionality ..... 4-2

    Link Active Scheduler (LAS) ..... 4-2

    LAS Hierarchy ..... 4-2

**Starting the FOUNDATION Fieldbus Application** ..... 4-3

**Working Online with Fieldbus Devices** ..... 4-4

    Connecting to a Fieldbus Device ..... 4-4

    Displaying the Connected Fieldbus Devices ..... 4-7

    Displaying the Device Blocks ..... 4-8

    Displaying a Device Menu ..... 4-8

    Block Modes ..... 4-9

    Device Blocks ..... 4-11

    Displaying Graphics ..... 4-15

**Configuring the FOUNDATION Fieldbus Application** ..... 4-16

    Changing the Fieldbus Polling Addresses ..... 4-16

    Changing the Slot Time ..... 4-16

    Viewing Available Device Descriptions ..... 4-16

**Running Fieldbus Diagnostics** ..... 4-17

    DC Voltage Measurement ..... 4-17

    Noise Level Measurement ..... 4-17

    Signal Level Measurement ..... 4-17

**Disconnecting from a Fieldbus Device** ..... 4-18

## SECTION 5 Troubleshooting

<b>Overview</b> .....	<b>5-1</b>
Troubleshooting Suggestions .....	5-1
<b>Error and Status Messages</b> .....	<b>5-5</b>
<b>Information for Technical Support</b> .....	<b>5-9</b>

## APPENDIX A Reference Data

<b>Processor and Memory Specifications</b> .....	<b>A-1</b>
Microprocessor .....	A-1
Memory .....	A-1
<b>Physical Specifications</b> .....	<b>A-1</b>
Weight .....	A-1
Display .....	A-1
Keypad .....	A-1
<b>Usage Specifications</b> .....	<b>A-1</b>
Temperature Limits .....	A-1
Storage with Batteries .....	A-1
Storage Without Batteries .....	A-1
Enclosure Rating .....	A-1
Shock .....	A-2
General Guidelines .....	A-2
<b>Connection Specifications</b> .....	<b>A-2</b>
HART and Fieldbus Communication Terminals .....	A-2
Connection Types .....	A-2
<b>Battery Specifications</b> .....	<b>A-2</b>
Battery Type .....	A-2
Connection .....	A-2
Charge .....	A-2
Lights .....	A-3
Operating Time .....	A-3
Storage .....	A-3
<b>Power Supply/Charger Specifications</b> .....	<b>A-3</b>
Connection .....	A-3
Lights .....	A-3
Voltage .....	A-3
Technical Data .....	A-4
<b>Order Information</b> .....	<b>A-5</b>
<b>Spare Parts List</b> .....	<b>A-6</b>

## APPENDIX B Product Certifications

<b>Overview</b> .....	<b>B-1</b>
<b>Approved Manufacturing Locations</b> .....	<b>B-1</b>
<b>FCC</b> .....	<b>B-1</b>
<b>IC</b> .....	<b>B-1</b>
<b>European Directive Information - CE Compliance</b> .....	<b>B-2</b>
R&TTE .....	B-2
Electro Magnetic Compatibility (2004/108/EC) .....	B-2
ATEX Directive (94/9/EC) (KL option only) .....	B-2
<b>Hazardous Locations Certifications (KL option only)</b> .....	<b>B-2</b>
European Certifications .....	B-2
International Certification .....	B-3
North American Certifications .....	B-3
<b>Power Supply/Charger Certification</b> .....	<b>B-3</b>

Declaration of Conformity/Approvals ..... B-3  
**Label Drawings**..... **B-3**  
**Approval Drawings**..... **B-6**

**APPENDIX C**  
**Graphics Information**

**Overview** ..... **C-1**  
**Screen Layout**..... **C-1**  
**Buttons** ..... **C-2**  
**Graphics Options**..... **C-2**  
    Images ..... C-2  
    Charts ..... C-3  
    Graphs..... C-5  
  
**Glossary** ..... **G-i**  
  
**Index** ..... **I-1**

## SECTION 1

## INTRODUCTION

### USING THIS MANUAL

The sections in this manual provide the following information on the 475 Field Communicator.

**Section 2: Learning the Basics** contains information on assembly, components, starting, entering standby, shutting down, settings, supported PC applications, and maintaining the 475 Field Communicator.

**Section 3: HART Functionality** contains information on starting and configuring the HART® Application, working offline, communicating with HART devices, modifying device parameters, and running diagnostics.

**Section 4: Fieldbus Functionality** contains information on starting and configuring the Fieldbus Application, communicating with fieldbus devices, modifying device parameters, and running diagnostics.

**Section 5: Troubleshooting** provides solutions to the most common 475 Field Communicator operating problems.

**Appendix A: Reference Data** provides physical, functional, and performance specifications.

**Appendix B: Product Certifications** contains Hazardous Location and International Certifications, European directive information, and approval drawings.

**Appendix C: Graphics Information** contains an overview of the Graphics functionality and options in the 475 Field Communicator.

---





## SECTION 2

## LEARNING THE BASICS

### OVERVIEW

This section provides instructions on basic features and functions of the 475 Field Communicator. It also provides information on assembly, components, starting, entering standby, shutting down, settings, applications, and maintaining the 475 Field Communicator. The functionality described in this section is based on system software version 3.0.

### SAFETY MESSAGES

Procedures and instructions in this section may require special precautions to ensure the safety of the personnel performing the operation. Information that raises potential safety issues is indicated by a warning symbol () . Refer to the safety messages before performing an operation preceded by this symbol. See the "Troubleshooting" section for more warning messages.

#### WARNING

This equipment has been tested and found to comply with the limits for a Class A digital device, pursuant to part 15 of the FCC Rules. These limits are designed to provide reasonable protection against harmful interference when the equipment is operated in a commercial environment. This equipment generates, uses, and can radiate radio frequency energy and, if not installed and used in accordance with the user's manual, may cause harmful interference to radio communications. Operation of this equipment in a residential area is likely to cause harmful interference in which case the user will be required to correct the interference at his own expense.

This device complies with Part 15 of the FCC Rules. Operation is subject to the following two conditions: (1) this device may not cause harmful interference, and (2) this device must accept any interference received, including interference that may cause undesired operation.

Any modifications made to this device that are not approved by Emerson Process Management may void the authority granted to the user by the FCC to operate this equipment.

This Class A digital apparatus complies with Canadian ICES-003.

#### WARNING

You can install or remove the Li-Ion battery (Power Module) in a hazardous area environment. You cannot charge the battery in this environment because the power supply/charger (00375-0003-0005) is not IS-approved.

## 475 FIELD COMMUNICATOR OVERVIEW

The 475 Field Communicator includes a color LCD touch screen, a Lithium Ion battery (Power Module), a SH3 processor, memory components, and integral communication and measurement circuitry.

The 475 Field Communicator supports HART and FOUNDATION fieldbus devices, letting you configure, maintain, or troubleshoot devices. When using the 475 Field Communicator to communicate with devices, follow all standards and procedures applicable to the location. Failure to comply may result in equipment damage and/or personal injury. Be sure to understand and comply with the sections in this manual.

### Device Interoperability

The 475 Field Communicator is designed to operate with a wide range of HART and FOUNDATION fieldbus devices independent of device manufacturer. Device interoperability is achieved through the Electronic Device Description Language (EDDL) technology supported by the HART Communication Foundation and Fieldbus Foundation.

Basic testing is performed on all device descriptions. Each device manufacturer is asked to certify that they thoroughly tested their devices with the 475 Field Communicator. If certification is not received, a warning message displays when you attempt to communicate with an untested device. New device descriptions are available from the Field Communicator Easy Upgrade Utility.

### Working in a Hazardous Area

An Intrinsically Safe (IS-approved) 475 Field Communicator can be used in Zone 0 (FM and CSA only), Zone 1, or Zone 2, for Group IIC, and Class I, Division 1 and Division 2, Groups A, B, C, and D locations.

An IS-approved 475 Field Communicator may be connected to loops or segments that are attached to equipment located in Zone 0, Zone 1, Zone 2, for Group IIC; Zone 20, Zone 21, Zone 22, and Class I, Division 1 and Division 2, Groups A, B, C, and D locations.

IS-approved 475 Field Communicators are ordered with the KL option and have an additional label on the back of the 475 that lists the approvals.

See Appendix B "Product Certifications" for more information about IS approvals and installations.

---

#### CAUTION

You can install or remove the Li-Ion battery in a hazardous area environment. You cannot charge the battery in this environment because the power supply/charger is not IS-approved.

---

## Battery and Power Supply/Charger

The 475 Field Communicator is powered by a Lithium Ion battery (Power Module) that has a green, 6-pin connector. The power supply/charger also has a green connector to match the appropriate connector on the battery. See Figure 2-1 for the location of the connector.

Prior to using the 475 Field Communicator without the power supply/charger connected, fully charge the battery.

### Guidelines and Precautions

Before using the battery or power supply/charger, understand and follow the guidelines and precautions below.

- When transporting a Li-Ion battery, follow all applicable regulations.
- Charge the battery with only the Field Communicator power supply/charger. The power supply/charger should not be used with other products. Failure to comply may permanently damage your 475 Field Communicator and will void the IS approval and the warranty.
- Protect the battery and power supply/charger from moisture, and respect operating and storage temperature limits. See Appendix A “Reference Data” for more information.
- Do not cover the battery or power supply/charger, subject it to prolonged periods of direct sunlight, or place it upon or next to heat-sensitive materials.
- Do not open or modify the battery or power supply/charger. There are no user-serviceable components or safety elements inside. Opening or modifying them will void the warranty and could cause personal harm.

### Checking the Remaining Charge

To view the remaining charge, press the Charge Indicator button on the lower left side of the battery. See Figure 2-1 for the location of this button. When you press and release the button, the lights above the button slowly illuminate to display the charge remaining. Each light represents 20 percent of the charge. The battery is fully charged when all of the lights are illuminated.

You can also check the remaining charge from the Settings menu on the Field Communicator Main Menu. See “Power Status” on page 2-14 for more information.

Figure 2-1. Li-Ion Battery Example

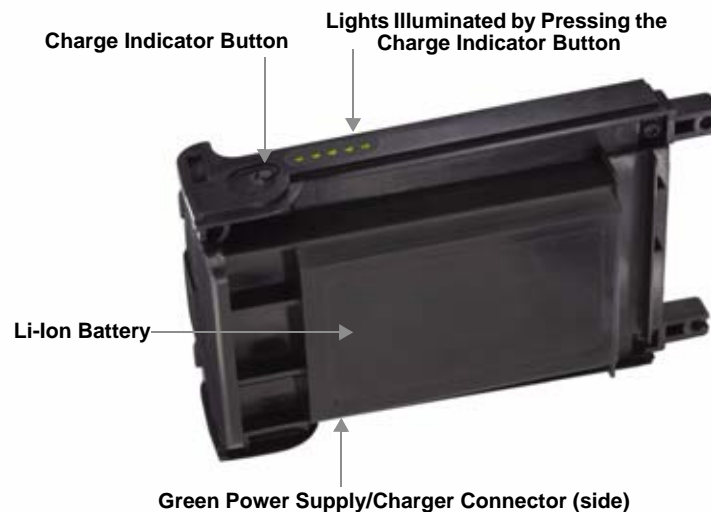

### Charging the Battery

Prior to first portable use, fully charge the battery. The battery can be charged separately or while attached to the 475 Field Communicator. The 475 Field Communicator is fully operable while the battery is recharging, and a full charge takes 2-3 hours. An overcharge condition will not occur if the power supply/charger remains connected.

#### **⚠ CAUTION**

You can remove and install the battery in a hazardous area environment. You cannot charge the battery in this environment because the power supply/charger is not IS-approved.

To charge the battery:

1. Plug the power supply/charger into a power outlet.
2. Plug the green power supply/charger connector into the green connector on the battery. The flat side of the power supply/charger connector should face the front of the 475 or the inside of the battery, if the battery is not attached to the 475. The battery is fully charged when the light on the power supply/charger is green.

Figure 2-2. Charging the Battery Connected to the 475 Field Communicator



### Power Supply/Charger Lights

Three lights are on the power supply/charger to indicate the conditions below. Each light displays a different color.

Table 2-1. Power Supply/Charger Lights

Color	Condition
Green	The battery is fully charged.
Flashing green	The battery is nearly fully charged.
Amber	The battery is charging.
Flashing amber	The power supply/charger is not connected to the 475 Field Communicator.
Flashing amber and red	The remaining charge in the battery is very low.
Red	Charging cannot occur. Contact Technical Support for more information.

### Maintaining the Battery

To help maintain the performance and life of the Li-Ion battery, understand and follow the guidelines below:

- Recharge the battery frequently, preferably after each use or at night. Limit the number of full discharges, if possible.
- Frequent use at high temperatures can reduce performance.
- Use a dry location at or near room temperature when storing the battery for an extended time. Prolonged storage at higher temperatures can reduce performance.
- Ensure the remaining charge level is at or near mid-capacity when storing for an extended time. The remaining charge will slowly drain during storage. Periodically charge the battery to ensure the remaining charge does not drain to low levels.

Figure 2-3. 475 Field Communicator shown without optional Rubber Boot



## Using the Touch Screen



The touch screen display lets you select and enter text by touching the screen. Tap the screen once to select a menu item or a button. Double-tap to open a menu item.

---

### CAUTION

Contact the touch screen with blunt items only, preferably the stylus included with the 475 Field Communicator. See Figure 2-3 on page 2-6 for the location of the stylus. Sharp instruments, such as screwdrivers, can damage the touch screen. Repairing the touch screen requires replacement of the entire display assembly, which is possible only at an authorized service center.

---

Use the back arrow icon () on the window to return to the previous menu. Use the close icon () in the upper right corner of the window to end the application.

If the touch screen seems inaccurate, you can recalibrate it. For more information, see "Touch Screen Alignment" on page 2-14.

---

### NOTE

All instructions in this manual are written for the touch screen.

---

### Use the Soft Input Panel (SIP) Keyboard

The SIP keyboard allows for alphanumeric input using the touch screen. The SIP keyboard detects when you need to enter characters and appears automatically as required.

## Using the Keypad

The following section describes the buttons on the 475 Field Communicator keypad.

### Bluetooth Symbol ()

The Bluetooth symbol on the keypad is illuminated by a blue light when Bluetooth is enabled from the Listen For PC window. The 475 Field Communicator must be licensed for Bluetooth to use this functionality.

### Power Key

The Power key is used to power on and off the 475 Field Communicator or to put it in standby. The green light on the Power key flashes when you press and hold the Power key to turn on the 475 Field Communicator. The light is constant when the 475 is on, and it slowly blinks when the 475 is in standby.

If the Power key is pressed when there is unsent data or a device method is running, a warning message appears. Tap **OK** to have the 475 Field Communicator enter standby or shut down, or tap **Cancel** to return to the previous window.

The Power key is disabled when the 475 Field Communicator is in Listen For PC mode or when the ScratchPad application is open.

### Arrow Navigation Keys

Four arrow navigation keys let you move through the menus in the applications. Press the up and down arrow keys to select a menu item, the right arrow key to open a menu item, or the left arrow key to return to the previous menu.

The blue text near the keys indicates alternate functionality that can be enabled by pressing the Function key.

### Enter Key

The Enter key lets you open the selected (highlighted) button on a window or a menu item on the Field Communicator Main Menu or Settings Menu. For example, if you push the Enter key when the Cancel button on a window is selected, you will close that window.

### Tab Key

The Tab key lets you move between selectable controls on a window.

### Alphanumeric Keypad

The alphanumeric keypad lets you enter letters, digits, and other characters, such as punctuation marks. The 475 Field Communicator automatically determines which text options are available depending upon the input necessary for the particular field.

To enter text when in alphanumeric mode, press the desired keypad button in quick repetition to scroll through the options to display the appropriate letter or number. For example, to type the letter Z, press the 9 key quickly four times.

The blue text near the keys indicates alternate functionality that can be enabled by pressing the Function key. The alternate function on the alphanumeric 5 key (insert) will be activated in future releases of the 475 Field Communicator software.

### Backlight Key

The Backlight key lets you adjust the intensity of the touch screen display. There are four different settings. The intensity impacts the charge in the battery. Expect a shorter charge life for higher intensities. See “Backlight” on page 2-12 for information on timers that can turn off the backlight after specified periods of inactivity. These timers can help conserve the battery power.

### Function (Fn) Key

The Function key lets you enable alternate functionality on select keys. The blue text near the other keys on the keypad indicate the alternate functionality. When the Function key is enabled, the orange light in the left corner of the Function key appears and the FN button on the Soft Input Panel (SIP), if displayed, is highlighted. Press the Function key again to disable the functionality and turn off the light.

## Memory

### Types

The 475 Field Communicator memory consists of three components:

1. Internal Flash—32MB non-volatile RAM. The Internal Flash memory stores the operating system and system software. It also stores the following:
  - Up to 25 HART configurations
  - HART Event Captures
  - FOUNDATION fieldbus statistics
  - Text files saved from ScratchPad
2. System Card—an internal 1 GB or higher Secure Digital Card with non-volatile flash memory. A copy of installable system software exists on every System Card. The System Card also contains all HART and FOUNDATION fieldbus device descriptions and can store up to 1,000 HART configurations, depending on the sizes of the files.
3. RAM—32MB used only for program execution.

### Available Memory Space

To view the available memory in your 475 Field Communicator, connect to the Field Communicator Easy Upgrade Utility or double-tap **Memory** from the Settings menu. The Field Communicator Main Menu displays the Settings menu item. See “Memory” on page 2-13 for more information.



### Free Memory on the System Card

Over time, your System Card may become full and unable to store new files. To free memory on your System Card, use the Memory Management feature in the Field Communicator Easy Upgrade Utility. This lets you select which device descriptions can be transferred onto your System Card. Device descriptions from selected manufacturers or protocols are omitted during an upgrade, allowing more space for other files.

If the selected device descriptions are already on your 475, they are removed the next time you connect the 475 Field Communicator to the Easy Upgrade Utility. You are prompted before the files are removed. See the Easy Upgrade Utility Help for more information.

## Accessories

### Rubber Boot

A rubber boot can be purchased to further protect your 475 Field Communicator. The boot has an additional stand on the back.

### Straps

Two straps are available with the 475 Field Communicator. The magnetic strap attaches to the top of the 475 Field Communicator and lets you hang it from a metal pipe. The strap attachment is located near the HART and fieldbus terminals on the top of the 475 Field Communicator.

The side strap lets you attach a strap to the sides or back of the 475 Field Communicator, making it easy to carry. See Figure 2-4. The side strap also holds the stylus used with the touch screen.

Figure 2-4. Side Strap Example



## ASSEMBLY

### Installing the System Card and the Battery

1. Place the 475 Field Communicator face down on a level, secure surface.
2. Remove the protective rubber boot, if attached.
3. With the battery removed, slide the System Card (labeled System Card), with the metal card contacts facing up, into the System Card socket until it clicks. The System Card socket is spring-loaded. See Figure 2-5 for the location of the System Card socket.

#### NOTE

The System Card is not locked into the System Card socket in the image below.

Figure 2-5. Back of the 475 Field Communicator

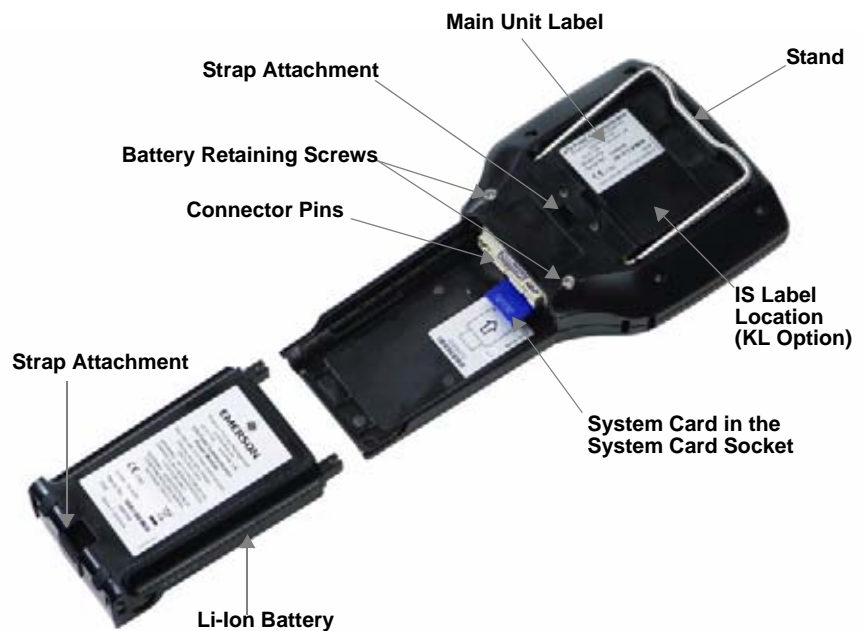

#### CAUTION

The System Card must be supplied by the 475 Field Communicator manufacturer. Failure to comply will void the IS approval.

4. With the 475 Field Communicator still face down, ensure the tops of the two battery retaining screws are loose and slightly above the top of the 475.
5. Align the sides of the battery with the 475 and carefully slide it forward until it is secure.
6. Carefully hand tighten the two battery retaining screws to secure the battery. (Do not over tighten, 0.5Nm maximum torque load.)

#### CAUTION

The connector pins may be damaged if the 475 Field Communicator and battery are improperly aligned.

## Removing the Battery and the System Card

To remove the battery and System Card:

1. Remove the rubber boot, if attached.
2. Place the 475 Field Communicator face down on a level, secure surface.
3. Loosen the battery retaining screws until the top of each screw is slightly above the top of the 475 Field Communicator.
4. Slide the battery off the 475 Field Communicator. Do not pull up the battery because this could damage the connector pins.
5. Push the System Card into the System Card socket until it clicks to release it. The System Card socket is spring-loaded.
6. Grasp the System Card with your fingers and slide it straight out of the 475 Field Communicator.

## STARTING UP AND SHUTTING DOWN

Prior to using the 475 Field Communicator without the power supply/charger, fully charge the battery. See “Charging the Battery” on page 2-4 for more information.

Before operating the 475 Field Communicator, ensure:

- The 475 Field Communicator is not damaged.
- The battery is fully seated.
- All screws are sufficiently tightened.
- The communication terminal recess is free of dirt and debris.

### Starting Up

Press and hold the Power key on the keypad until the green light on that key flashes (approximately two seconds). See Figure 2-3 on page 2-6 for the location of the Power key.

During startup, the 475 Field Communicator automatically checks for any system software upgrades available on the internal System Card. You are notified if an upgrade is on the System Card and ready to be installed. The Field Communicator Main Menu appears.

### The Field Communicator Main Menu

The Field Communicator Main Menu is the first menu that appears after you start the 475 Field Communicator. This menu lets you run the HART and the FOUNDATION Fieldbus applications, view the Settings menu, communicate with a PC, and launch ScratchPad. See Section 3 “HART Functionality” and Section 4 “Fieldbus Functionality” for more information on these applications.

Figure 2-6. Field Communicator Main Menu

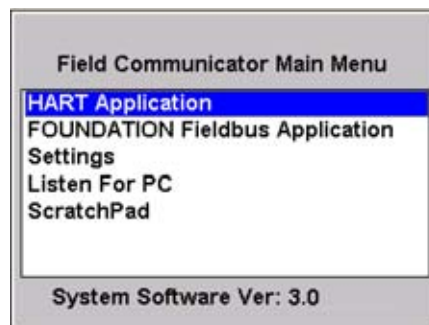

## Entering Standby

You can put the 475 Field Communicator into standby to save power or to reduce the boot-up time if you are using the 475 Field Communicator intermittently. Standby turns off the touch screen and areas within the 475 Field Communicator.

You can put the 475 Field Communicator in standby when the HART Application or the Fieldbus Application is running. If you are working online with a device when standby is entered, the application main menu is displayed when the 475 Field Communicator returns from standby. Otherwise, the 475 Field Communicator displays the last open window.

To enter standby, press the Power key. From the Power Switch dialog box, tap **Stand by** and tap **OK** or press the Enter key. Tap **Cancel** to close the dialog box and return to the application. The green light on the Power key slowly flashes when the 475 Field Communicator is in standby. To leave standby, press the Power key.

The 475 Field Communicator also enters standby if the standby timer has expired. See "Power Status" on page 2-14 for more information.

## Shutting Down

To shut down the 475 Field Communicator, press the Power key. From the Power Switch dialog box, tap **Shut down** and tap **OK** or press the Enter key. Tap **Cancel** to close the dialog box and return to the application.

The 475 Field Communicator shuts down if the auto-off timer has expired. See "Power Status" on page 2-14 for more information.

You can also shut down the 475 Field Communicator by simultaneously pressing the Backlight key and the Function key until the display turns off. The shut down is accomplished in the hardware (similar to removing the power to a PC using a switch). This is not the recommended way of shutting off the 475 Field Communicator.

## SETTINGS

You can view and modify the options below for the 475 Field Communicator from the Settings option on the Field Communicator Main Menu.

### About Field Communicator

About Field Communicator lets you view the software revisions in your 475 Field Communicator. If you need to call Technical Support personnel, have the system software version, Communication and Diagnostic Circuitry (CDC) version, and the operating system version available.

Tapping **RE-IMAGE** re-installs the operating system, system software, and applications on your 475 Field Communicator. The power supply/charger must be connected when the RE-IMAGE operation is performed. During the operation, the standby and auto-off timers are disabled. This operation should only be performed under the direction of Technical Support personnel.

Tapping **RE-FLASH** re-installs the firmware and software from the System Card. The power supply/charger must be connected when the RE-FLASH operation is performed. During the operation, the standby and auto-off timers are disabled. This operation should only be performed under the direction of Technical Support personnel.

Tap **OK** to return to the Settings menu.

### Backlight

The Backlight setting lets you adjust the backlight intensity of the screen. To adjust the backlight, drag the slider left to right.

The Backlight setting also lets you set timers to automatically turn off the backlight after a specified period of inactivity to save battery power. To enable a timer, tap a drop-down list and select the appropriate time interval. The external power timer applies when the power supply/charger is connected to the 475 Field Communicator. After you select the appropriate backlight settings, tap **OK** to retain this setting for this session only, **SET DEFAULT** to retain this setting upon startup, or **CANCEL** to exit without changes.

## Clock

The Clock setting lets you set the date, time, and time zone on the 475 Field Communicator. Configure the date by using the drop-down list. To configure the time, select the appropriate time field and use the arrows to scroll through values until you find the correct time. Select the drop-down list to select a time zone. Tap **OK** to save the changes and to close the window, or **CANCEL** to exit without changes.

## Contrast

The Contrast setting lets you adjust the lightest and darkest areas on the window. This option applies to only the 375 Field Communicator.

---

### NOTE

Temperature can affect contrast.

---

## License

The License setting lets you view the enabled and available licenses for the 475 Field Communicator. A checkmark indicates the license is enabled. Unlicensed features cannot be accessed. The following licenses and information are displayed:

- HART - enables your 475 to run the HART Application to communicate with HART devices.
- Graphics - enables your 475 Field Communicator to display device information as images, charts, and graphs.
- Easy Upgrade - enables you to upgrade your 475 Field Communicator with the latest system software and device descriptions at your site, without having to send it to a service center.
- Exp Date - displays the expiration date of the Easy Upgrade license. The date is listed as year-month-day. The field is empty if Easy Upgrade is licensed, but you have not connected the 475 to the Field Communicator Easy Upgrade Utility. Connecting to the Easy Upgrade Utility sets the expiration date. N/A appears if the 475 is not licensed for Easy Upgrade.
- Bluetooth - enables your 475 Field Communicator to communicate with supported PC applications, such as the Easy Upgrade Utility, using Bluetooth.
- FOUNDATION fieldbus - enables the 475 Field Communicator to run the FOUNDATION Fieldbus Application to communicate with fieldbus devices.
- Device Config Management - enables you to save HART device or user configurations to the System Card and to print and store them using the Easy Upgrade Utility.

The License window also displays the Unit Name and System Card Serial Number (SN) of the 475 Field Communicator. See the Easy Upgrade Utility Help for more details on assigning a Unit Name. Tap **OK** to return to the Settings menu.

## Memory

The Memory setting lets you view available free space in the System Card, Internal Flash, or RAM. If you have less than 10 percent of memory free, the value is highlighted yellow.

## Power Status

The Power Status setting lets you specify power management options when the 475 Field Communicator is on battery power. The standby timer puts the 475 Field Communicator in standby and the auto-off timer shuts down the 475 Field Communicator after the specified values of inactivity. To specify values for the standby or auto-off timer, select the time intervals from the drop-down lists. If set to short intervals, these timers will save battery power.

The Maximize Power Savings option conserves additional battery power by letting the 475 Field Communicator enter standby or shut down when communicating with a device. To enable Maximize Power Savings, tap the checkbox. If this option is disabled, the 475 Field Communicator will not enter standby or shut down when communicating with a device.

After you select the appropriate power management settings, tap **OK** to apply the settings for this session only, **SET DEFAULT** to retain the settings upon startup, or **CANCEL** to exit without changes.

## Retrain The Battery

The Retrain The Battery setting lets you fully discharge the battery so it can be charged to its full capacity. Perform this operation if you notice a significant decrease in charge life or performance.

---

### CAUTION

It should not be necessary to perform this operation on a regular basis. Doing so may damage the Li-Ion battery.

---

Ensure the power supply/charger is not connected when this operation is performed. During the operation, the backlight is set to its brightest setting to quickly discharge the battery. The backlight, standby, and auto-off timers are disabled. If you tap **CANCEL**, the battery stops discharging and the backlight, standby, and auto-off timers are re-enabled. The backlight setting is also restored.

After the battery is fully discharged, make sure it is fully recharged before using it without the power supply/charger. You can use the 475 Field Communicator while the battery is recharging.

To retrain the battery:

1. Disconnect the power supply/charger, if it is connected to the 475 Field Communicator.
2. Double-tap **Retrain The Battery** from the Settings menu.
3. Wait until the 475 Field Communicator shuts down. It may take up to several hours to discharge the battery, depending on the charge remaining when the operation began.
4. Connect the power supply/charger to the 475 Field Communicator and fully charge the battery.

## Touch Screen Alignment

The Touch Screen Alignment setting lets you calibrate the touch screen with the display. Tap the center of the cross hairs firmly and accurately at each location on the window. The target continues to move until the touch screen is aligned. Touch screen alignment is retained upon start up.

## Event Capture

The Event Capture setting lets you create an Event Capture file (.rec), which is a log of communication, input, and output that occurs between the 475 Field Communicator and a device (HART only). When working with Technical Support personnel, you may be asked to create an Event Capture file to help troubleshoot issues that cannot be easily isolated or resolved. The Event Capture file can then be transferred to your PC using the Field Communicator Easy Upgrade Utility and sent to Technical Support personnel for review.

Tap the option to activate the Event Capture feature. The option is black when selected. To delete an existing Event Capture, tap **DELETE EVENT FILE**.

---

### NOTE

While Event Capture is enabled, device status and warning messages do not appear.

---

To create and send an Event Capture file:

1. Double-tap **Settings** from the Field Communicator Main Menu.
2. Double-tap **Event Capture**.
3. Tap **Turn on HART event capture** from the Event Capture window and tap **OK**.
4. Double-tap **HART Application** from the Field Communicator Main Menu.
5. Enter a file name for the Event Capture file and tap **OK**. The file is saved to a default location.
6. Perform the requested operations to capture the data.
7. Use the Field Communicator Easy Upgrade Utility to transfer the file from your 475 Field Communicator to your PC. See the Easy Upgrade Utility Help for more information.

## Exit to Main Menu

Double-tap **Exit to Main Menu** if you want to return to the Field Communicator Main Menu.

## CONNECTING TO A DEVICE

Use the provided lead set and the HART or FOUNDATION Fieldbus (if licensed) Applications to connect and communicate with a device. The appropriate device description is also required. If the 475 Field Communicator does not have the HART device description, the device can be displayed in forward compatibility mode. This mode uses a generic device description and does not display all device functionality. Three terminals for the lead set are on the top of the 475 Field Communicator. Each red terminal is a positive connection for its protocol, while the black terminal is a common terminal shared by both protocols. An access door ensures only one pair of terminals is exposed at any one time. Several markings indicate which pair of terminals is for which protocol.

See Section 3 HART Functionality and Section 4 Fieldbus Functionality for wiring diagrams and more information. Appendix B displays diagrams for Intrinsically Safe installations.

## PC APPLICATIONS

Connect your 475 Field Communicator to a supported PC application, such as AMS<sup>®</sup> Suite: Intelligent Device Manager or the Easy Upgrade Utility, to download new system software, device descriptions, and licenses. You can also transfer HART configuration files, Event Capture files, and ScratchPad(.txt) files to a PC.

### AMS Device Manager

The 475 Field Communicator can connect to AMS Device Manager (version 6.2 or higher), letting you create, open, edit, or compare HART device or user configuration files. You may need to connect using IrDA if Bluetooth is not supported in your version. You can also download configurations from AMS Device Manager to a storage location in the 475 Field Communicator. Check the AMS Device Manager Books Online for more information.

### Field Communicator Easy Upgrade Utility

The 475 Field Communicator can connect to the Easy Upgrade Utility that is available on the Resource CD. See the readme file for installation and system requirements. You can access this file from [www.fieldcommunicator.com](http://www.fieldcommunicator.com) or the Resource CD.

The Easy Upgrade Utility lets you do the following:

- Download new system software and device descriptions to upgrade your 475 Field Communicator at your site.
- Enable new functionality and applications by purchasing and downloading new application licenses using the Online Licensing feature.
- Upload Event Capture and ScratchPad files to your PC.
- Upload, download, and print HART device or user configurations (.hcf files). Uploading configurations to the Easy Upgrade Utility lets you back up these files.
- Manage the memory in your System Card by specifying which device descriptions can be downloaded to your System Card. Limiting the number of device descriptions will free memory on your System Card.
- Assign a Unit Name to a 475 Field Communicator to uniquely identify it, which is useful when connecting to a 475 using Bluetooth.

See the Easy Upgrade Utility Help for more information on these features.



## Connecting the 475 Field Communicator or System Card

You can use three connection types to connect a 475 Field Communicator to the Easy Upgrade Utility: IrDA, Bluetooth (if licensed), or a supported card reader. The 475 Field Communicator must be in Listen For PC mode to communicate through IrDA or Bluetooth. See the AMS Device Manager Books Online for information on supported connection types.

Certain connection types are required to transfer files or information between the Field Communicator Easy Upgrade Utility and a 475 Field Communicator. See Table 2-2.

Table 2-2. Required Connection Types to Transfer Files Using the Easy Upgrade Utility

File to Transfer	Required Connection Type
Device Descriptions*	IrDA, Bluetooth, or a Card Reader
Event Capture Files	IrDA or Bluetooth
HART Device or User Configuration Files	IrDA, Bluetooth, or a Card Reader
Licenses	IrDA or Bluetooth
ScratchPad (.txt) Files	IrDA or Bluetooth
System Software*	IrDA, Bluetooth, or a Card Reader
Unit Name	IrDA or Bluetooth

\*Some upgrades may require a card reader.

### Listen For PC

The Listen For PC option lets you select IrDA or Bluetooth as the connection type to communicate with a PC. To enter Listen For PC mode, double-tap **Listen For PC** from the Field Communicator Main Menu. IrDA is initially set as the default connection type and is automatically enabled when you open Listen For PC.

You can change the connection type at any time by tapping the **Change Connection Type** button and then selecting an option. Tap **OK** to use the selected connection type for only the current session. The default connection type is used the next time you open Listen For PC. Tap **Save as Default** to always use the selected connection type when Listen For PC is opened.

After you select the connection type, the 475 Field Communicator waits for a connection from the PC. When the 475 is connected, a message appears and the PC name is listed in the Connected PC field on the Listen For PC window.

### NOTE

The Power key, standby timer, and auto-off timer are disabled when the 475 Field Communicator is in Listen For PC mode.

### Bluetooth

The Bluetooth interface (if licensed) lets your 475 Field Communicator connect to the Field Communicator Easy Upgrade Utility version 3.0 or higher to transfer device descriptions, system software, configurations, Event Captures, application licenses, and ScratchPad (.txt) files. Check your AMS Device Manager documentation to see if Bluetooth is supported. The 475 Field Communicator does not communicate with HART or fieldbus devices using Bluetooth.

To use Bluetooth, you need the following:

- 475 Field Communicator with a Bluetooth license. To see if your 475 is licensed for Bluetooth, double-tap **Settings** from the Field Communicator Main Menu. Then double-tap **License**. A checkmark next to Bluetooth indicates it is licensed.
- An approved Bluetooth adapter attached to your PC that uses the Windows Bluetooth software and drivers. See the Easy Upgrade Utility Help and readme file for more information. You can access the readme file from [www.fieldcommunicator.com](http://www.fieldcommunicator.com), the Resource CD, or the Field Communicator Easy Upgrade Utility menu in the Windows Start menu (if the Easy Upgrade Utility has been installed.)

If Bluetooth is not set as the default, you need to enable it on the Listen For PC window. To enable Bluetooth communication:

1. Double-tap **Listen For PC** from the Field Communicator Main Menu.
2. Tap **Change Connection Type**.
3. Tap **Bluetooth** and then tap **OK**. You can tap **Save as Default** to always use Bluetooth as the connection type.

The Bluetooth symbol on the keypad is illuminated by a blue light () and a "Waiting for connection" message appears when Bluetooth is enabled. See Figure 2-3 for the location of this light.

The maximum recommended distance between the 475 Field Communicator and PC is 30 feet (10 meters). See the Help in the Easy Upgrade Utility or AMS Device Manager for more information about connecting using Bluetooth.

### IrDA

The 475 Field Communicator can communicate with the Easy Upgrade Utility and AMS Device Manager using infrared (IrDA) technology. IrDA is a PC interface supported for the transfer of device descriptions, software updates, configurations, Event Captures, application licenses, and ScratchPad files. See Figure 2-3 on page 2-6 for the location of the IrDA interface on the 475 Field Communicator. All 475 Field Communicators can use IrDA.

IrDA communication can either be built into the PC, such as a laptop, or provided through an adapter such as a USB to IrDA adapter. Refer to your IrDA manual for installation and operating instructions. The maximum recommended distance between the IrDA and PC is 18 inches.

If you previously set Bluetooth as the default connection type, you need to enable IrDA.

To enable IrDA communication:

1. Double-tap **Listen For PC** from the Field Communicator Main Menu.
2. Tap **Change Connection Type**.
3. Tap **IrDA** and then tap **OK**. You can tap **Save as Default** to always use IrDA as the connection type.

A "Waiting for connection" message appears when IrDA is enabled. See AMS Device Manager Books Online or the Easy Upgrade Utility Help for instructions to connect to those applications using IrDA.

---

**Card Reader**

The 475 Field Communicator System Card can also communicate with the Easy Upgrade Utility using a supported Secure Digital card reader. See the readme file for the supported card readers. You can access this file from [www.fieldcommunicator.com](http://www.fieldcommunicator.com), the Resource CD, or the Field Communicator Easy Upgrade Utility menu in the Windows Start menu (if the Easy Upgrade Utility has been installed.)

---

**CAUTION**

Using Windows Explorer and a card reader to manually transfer or copy files between the System Card and a PC can corrupt the System Card. This operation should only be performed under the direction of Technical Support personnel.

---

The card reader provides faster upload and download speeds than an IrDA adapter; however, it cannot transfer application licenses, Event Capture files, or ScratchPad files.

To access the System Card, you need to remove the battery from the 475 Field Communicator. See “Removing the Battery and the System Card” on page 2-11 for more information.

See the Easy Upgrade Utility Help for instructions to connect a System Card and card reader.

**Upgrading the 475 Field Communicator**

The Field Communicator Easy Upgrade Utility on the Resource CD lets you download new system software and device descriptions to upgrade your 475 Field Communicator at your site. To download new system software and device descriptions, your 475 Field Communicator must be licensed for Easy Upgrade.

You can also send your Field Communicator to a Service Center to be upgraded. For more information, contact your sales representative.

---

**CAUTION**

New system software and device descriptions must be downloaded and transferred to the 475 Field Communicator using the Easy Upgrade Utility. Manually copying files to the System Card using Windows Explorer will corrupt the System Card.

---

**Downloading New System Software and Device Descriptions**

Download the latest system software and device descriptions from the Internet by using the Update PC functionality in the Easy Upgrade Utility (version 3.0 or higher). An Internet connection is required to download the new files. If your site does not have Internet access, a Resource CD can provide the latest updates.

**Transferring the System Software and Device Descriptions**

Use the Easy Upgrade Utility to transfer all the files to a connected 475 Field Communicator. You can use IrDA, Bluetooth, or a card reader to connect to the Easy Upgrade Utility and transfer the upgrades. Large or critical upgrades may require a card reader. See the Easy Upgrade Utility Help for information on connecting and upgrading a 475 Field Communicator.

The Easy Upgrade Utility also lets you transfer a specific system software or device description version. Connect a 475 Field Communicator or System Card and click the More Options button on the Upgrade window to access the System Software and DDs tabs.

## Adding Functionality by Enabling Licenses

The HART Application, Device Configuration Management, and Graphics are licensed in all 475 Field Communicators, but other functionality requires a license. Renew or add licenses anytime at your site by using the Online Licensing feature in the Field Communicator Easy Upgrade Utility. Only the Easy Upgrade license needs to be renewed.

### Viewing Current Licenses

To view the current licenses and the Easy Upgrade expiration date in your 475 Field Communicator, double-tap **Settings** from the Field Communicator Main Menu. Then double-tap **License**.

The Easy Upgrade Utility can also display all licensing information from the Licensing & Registration window or Upgrade window. A 475 Field Communicator must be connected to view licensing information from the Upgrade window.

### Purchasing and Downloading New Licenses

You can select and enable new licenses for a 475 Field Communicator from your site. There are four basic steps to obtain new licenses:

1. Register your 475 Field Communicator by connecting it to the Easy Upgrade Utility and logging in to the Licensing & Registration window.
2. Select the licenses to purchase and note the appropriate part numbers. You can select licenses for multiple Field Communicators at one time.
3. Submit a purchase order to your sales representative. You are notified when your order has been processed and the licenses are available for download.
4. Connect the 475 Field Communicator to the Easy Upgrade Utility, and use the Licensing & Registration window to enable the purchased licenses.

See the Easy Upgrade Utility Help for more information on selecting and enabling licenses.

You can send your 475 Field Communicator to a service center to have a technician enable licenses for you. Contact your sales representative for more information.

## SCRATCHPAD

ScratchPad is a text editor that you can use to create, open, edit, and save simple text (.txt) documents. ScratchPad supports very basic formatting. From the Field Communicator Main Menu, double-tap **ScratchPad** to run the application. You can also launch ScratchPad from within the HART or Fieldbus Application by tapping the ScratchPad (📄) icon in the upper right corner of the window.

You can transfer text files between a PC and the 475 Field Communicator using the Field Communicator Easy Upgrade Utility.

---

### NOTE

The Power key, standby timer, and auto-off timer are disabled when the ScratchPad application is open.

---

## Creating a New Document

From the Main Page in ScratchPad, tap **NEW**. An empty text window and SIP keyboard appears. See Figure 2-7. You are now ready to enter text into your new document.

A new document can also be created within ScratchPad by tapping the New (📄) icon in the toolbar or by selecting **File | New** from the menu.

Figure 2-7. New Document in ScratchPad Displaying the SIP Keyboard

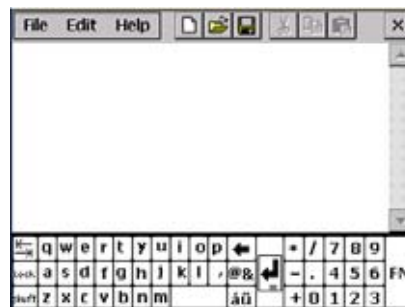

## Opening an Existing Document

1. From the Main Page in ScratchPad, select the desired file located under File Name.
2. Tap **OPEN**. A text window and the SIP keyboard appears. You are now ready to edit your document.

You can also open a document by selecting **File | Open** from the menu bar or by tapping the Open (📄) icon in the toolbar.

### Entering Text

Using the stylus, tap the desired letters from the SIP keyboard. Using the keypad, press the desired keypad button in quick repetitions to display the appropriate letter or number.

### Selecting Text

Drag the stylus over the desired text to highlight or to select all of the text in the document tap **Edit | Select All**.

### Cutting Text

1. Select the text to be cut.
2. Tap **Edit | Cut**.

You can also cut text by selecting text and tapping the Cut (✂️) icon in the toolbar.

### Copying Text

1. Select the text to be copied.
2. Tap **Edit | Copy**.

You can also copy text by selecting text and tapping the Copy () icon in the toolbar.

### Pasting Text

1. Copy the text to be pasted.
2. Tap a location on the screen. This is where the text will be pasted.
3. Tap **Edit | Paste**.

You can also paste text by copying the text and tapping the Paste () icon in the toolbar.

### Saving a Document

1. In your document, tap **File | Save**.
2. Type the file name in the dialog box if your document is new.
3. Tap **OK**.

You can also save a document by tapping the Save () icon in the toolbar.

### Saving a Copy

To save a copy of the current document under another name:

1. In your document, tap **File | Save As...**
2. Type the copy file name in the dialog box.
3. Tap **OK**.

### Deleting a Document

There are three options for deleting a ScratchPad document:

#### Option 1

1. From the Main Page in ScratchPad, select the file to be deleted.
2. Tap **DELETE**.
3. A warning appears telling you that the selected file will be permanently deleted. If you are sure you want to delete this file, tap **Yes**.

#### Option 2

1. To delete from your document, tap **File | Delete**.
2. From the Delete File Page, tap the desired file to be deleted.
3. Tap **OK**.
4. A warning appears telling you that the selected file will be permanently deleted. If you are sure you want to delete this file, tap **Yes**.
5. Tap **EXIT** when you are finished deleting files.

#### Option 3

Delete the .txt file using the Easy Upgrade Utility. See the Easy Upgrade Utility Help for more information on deleting a User Data file.

### Exiting

1. In your document, tap **File | Exit**.
2. Tap the **EXIT** button from the Main Page.

## **MAINTENANCE**

Any maintenance, repair, or replacement of components not listed below must be performed by specially trained personnel at authorized service centers. You can perform common maintenance procedures on the 475 Field Communicator, as described below:

- Cleaning the exterior. Use only a dry, lint-free towel or dampen the towel with a mild soap and water solution.
- Charging, removing, and replacing the battery.
- Removing and replacing the System Card.
- Removing and replacing the stand.
- Ensuring that all exterior screws are sufficiently tightened.
- Ensuring that the communication terminal recess is free of dirt and debris (does not require disassembly).

## **Running a Self Test**

There is no need, nor is it possible, to perform a manual self test with the 475 Field Communicator. Testing features are done automatically. A warning message appears if a fault condition is found during these tests.

## **Calibrating**

It is not necessary or possible to calibrate the 475 Field Communicator. The 475 Field Communicator is a communication interface that communicates digitally with HART and FOUNDATION fieldbus devices.

Voltage measurements made by the 475 Field Communicator are for use in detection of power or noise on a network, and are for reference purposes only. NIST standards are not applicable to the 475 Field Communicator.





## SECTION 3

# HART FUNCTIONALITY

### OVERVIEW

This section provides instruction on basic HART functionality in the 475 Field Communicator. It is based on the operation of the HART Application version 4.0.

### SAFETY MESSAGES

Procedures and instructions in this section may require special precautions to ensure the safety of the personnel performing the operation. Information that raises potential safety issues is indicated by a warning symbol () . Refer to the safety messages before performing an operation preceded by this symbol. Other warning messages can be found in the "Troubleshooting" section of this manual.

#### **WARNING**

If you choose to ignore all field device status messages, every message, regardless of severity, is ignored until the specified number of messages is reached. See "Ignoring Status Messages" on page 3-16 for more information.

#### **WARNING**

Voltage measurements are for reference purposes only. Do not make critical process control decisions based on these measurements.

---

## BASIC FEATURES AND FUNCTIONS

### HART Application Functionality

The HART Application lets you communicate with and configure HART devices that are connected to the 475 Field Communicator. You can also create and edit configurations and run diagnostics.

### Using a Fast Key Sequence

A Fast Key sequence is a sequence of numerical button presses, corresponding to the menu options that lead you to a given task. See your device documentation for fast key sequence options.

## STARTING THE HART APPLICATION

To start the HART Application:

1. Press and hold the Power key until the green light on that key blinks to turn on the 475 Field Communicator.
2. Double-tap **HART Application** from the Field Communicator Main Menu. If a live HART device is connected to the 475 Field Communicator, the HART Application Online menu appears automatically. If a device is not connected, the HART Application main menu appears after a few seconds. See Figure 3-1.

To return to the Field Communicator Main Menu, press the left arrow key on the keypad or tap the back arrow on the window.

From the HART Application main menu, you can choose Offline, Online, Utility, or HART Diagnostics functions. The rest of this section guides you through the HART Application menus and functions.

Figure 3-1. HART Application Main Menu

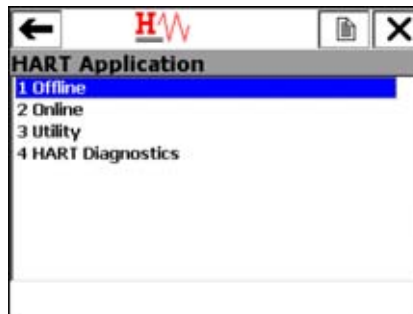

## WORKING WITH OFFLINE CONFIGURATIONS

The Offline menu lets you create offline configurations and view and change configurations stored in the 475 Field Communicator.

There are two types of HART configurations: device configurations and user configurations. A device configuration is created from a connected, online HART device. A user configuration is created offline or transferred to a 475 Field Communicator from another program. Editing a device configuration within the 475 Field Communicator changes it to a user configuration.

The concept of partial or standard configurations does not apply to the 475 Field Communicator. All configurations are full configurations.

### Creating a New Configuration

Creating a new configuration lets you create a user configuration for a specific device type and revision.

To create a new HART configuration while working offline:

1. From the HART Application main menu, double-tap **Offline**.
2. Double-tap **New Configuration**. The manufacturer names of the installed device descriptions are listed.
3. Double-tap the desired manufacturer to expand the list. The models available for the manufacturer are listed.
4. Double-tap the desired device model to expand the list. The device revisions available for the selected device model are listed.
5. Double-tap the desired device revision.
6. If a warning appears, thoroughly read the warning, tap **CONT** to accept the warning and proceed, or tap **EXIT**.
7. Mark (select) the configurable variables you want sent to the device; unmarked variables are not included when the configuration is transferred to a device. Double-tap **Mark all | OK** to have all variables marked. Double-tap **Unmark all | OK** to clear the marks from all variables. If a variable cannot be marked, an error message appears.  
To mark and edit variables individually:
  - a. Double-tap **Edit individually**.
  - b. Scroll through the list of variables and select the variable you want to mark or edit.
  - c. To change the value for the selected variable, tap **EDIT**, change the value, and tap **ENTER**. A "\*" symbol appears next to the variable name and the value is highlighted yellow to indicate the change has not been saved.  
To mark the selected variable, tap **MARK**. A "+" symbol appears next to the value.
  - d. Repeat these steps for other variables as necessary and tap **EXIT** when you are finished.
8. To save the configuration, double-tap **Save as**. (The SAVE button brings you to the Save as menu.)
  - a. To change the location where the configuration is saved, double-tap **Location**, select an option, and tap **ENTER**.
  - b. To specify a name for the configuration, double-tap **Name**, enter the name, and tap **ENTER**.
  - c. Tap **SAVE**.

## Opening a Saved Configuration

A saved configuration lets you edit, copy, send, delete, or rename it. You can also compare it to other saved configurations.

To open a saved configuration:

1. From the HART Application main menu, double-tap **Offline**.
2. Double-tap **Saved Configuration**.
3. Double-tap the storage location where you saved the configuration.

The **FILTR** button opens a menu that provides both sort and tag filter options. These options let you customize your view of saved configurations.

- The **Sort** option lets you group and display configurations according to your choice of configuration name, device tag, or device descriptor.
- The **Filter** option lets you limit which configurations are displayed by picking specific characters from the configuration name, device tag, or device descriptor.

When setting up a filter, you can use two special characters: the period (.) and the asterisk (\*). The period replaces a single character of any value. The asterisk replaces a string of characters.

For example, if you want to list all configurations that have a name of P - 001 to P - 300, enter "P - \*" in the filter. If you want to list configurations with a name that begins P - 0 and ends with a 7, set the filter to "P - 0.7". The period will replace only one character between the 0 and 7.

The **XPAND** button lets you view the configuration name, device tag, manufacturer, device type, device revision, descriptor, and the configuration type. Tap **CMPRS** to return to the previous window.

4. Double-tap the desired configuration to open the Saved Configuration menu.

### Editing a Saved Configuration

The **Edit** option lets you edit a saved configuration while working offline.

To edit a saved configuration:

1. Open a saved configuration. See "Opening a Saved Configuration".
2. Double-tap **Edit** from the Saved Configuration menu.
3. If a warning appears, thoroughly read the warning, tap **CONT** to accept the warning and proceed, or tap **EXIT** to end this operation.
4. Mark (select) the configurable variables you want sent to the device; unmarked variables are not included when the configuration is transferred to a device. Double-tap **Mark all | OK** to have all variables marked. Double-tap **Unmark all | OK** to clear the marks from all variables. To mark and edit variables individually:
  - a. Double-tap **Edit individually**.
  - b. Scroll through the list of variables and select the variable you want to mark or edit. To change the value for the selected variable, tap **EDIT**, change the value, and tap **ENTER**. A "\*" symbol appears next to the variable name and the value is highlighted yellow to indicate the change has not been saved. To mark the selected variable, tap **MARK**. A "+" symbol appears next to the value.
  - c. Repeat these steps for other variables as necessary.
  - d. Tap **Exit**.
5. Tap **SAVE**.

### Copying a Saved Configuration

The Copy to option lets you copy a saved configuration to a new storage location in the 475 Field Communicator.

To copy a saved configuration:

1. Open a saved configuration. See “Opening a Saved Configuration” on page 3-4.
2. Double-tap **Copy to** from the Saved Configuration menu.
3. Double-tap **Location** and select the new storage location to which you want to save the configuration, and tap **ENTER**.
4. Double-tap **Name**, enter the name for the copy of this configuration, and tap **ENTER**.
5. Tap **SAVE** to copy the configuration to a new location.

### Sending a Saved Configuration to a Connected Device

The Send option lets you send the open configuration to a connected device. From the Saved Configuration menu, double-tap **Send**. The 475 Field Communicator sends the configuration to a connected device that is compatible with the configuration.

### Deleting a Saved Configuration

The Delete option lets you remove saved configurations one at a time.

To delete a configuration from the 475 Field Communicator storage:

1. Open a saved configuration. See “Opening a Saved Configuration” on page 3-4.
2. Double-tap **Delete** from the Saved Configuration menu.
3. Tap **Yes** to confirm the deletion. Tap **No** to cancel.

### Renaming a Saved Configuration

The Rename option lets you change the name of a saved configuration.

To rename a saved configuration:

1. Open a saved configuration. See “Opening a Saved Configuration” on page 3-4.
2. Double-tap **Rename** from the Saved Configuration menu.
3. Double-tap the file you want to rename.
4. Enter the new file name and tap **ENTER**.
5. Tap **SAVE**.

### Comparing Two Saved Configurations

Any two configurations can be compared. A message appears indicating if differences exist, but the specific differences are not displayed.

To compare two saved configurations:

1. Open a saved configuration. See “Opening a Saved Configuration” on page 3-4.
2. Double-tap **Compare** from the Saved Configuration menu.
3. Double-tap **Location** and select the storage location containing the other configuration that will be used in this comparison and tap **ENTER**.
4. Double-tap **Name** to select the desired file to compare.
5. Tap **COMP** to compare the configurations.
6. Tap **OK** when you are finished.

## Transferring Configurations to a PC Application

You can transfer configurations (.hcf files) from the 475 Field Communicator to AMS Device Manager or the Field Communicator Easy Upgrade Utility. After you transfer the configuration, you can perform different operations depending on the application used.

### AMS Device Manager

Use AMS Device Manager to open, edit, compare, and transfer saved configurations. A Handheld or Field Communicator Interface kit for AMS Device Manager (version 6.2 or higher) lets you use the 475 Field Communicator with AMS Device Manager.

If the System Card does not appear as a storage location in AMS Device Manager, copy the configurations from the System Card into the Internal Flash in the 475 Field Communicator before connecting to AMS Device Manager. See "Copying a Saved Configuration" on page 3-5 for instructions. Then access the Internal Flash location to open, edit, and save the configurations in AMS Device Manager. See the AMS Device Manager Books Online for more information on connecting and transferring configurations.

### Field Communicator Easy Upgrade Utility

Use the Easy Upgrade Utility to back up, transfer, and print the configurations saved in your 475 Field Communicator. See the Easy Upgrade Utility Help for more information about connecting and transferring configurations.

## WORKING ONLINE WITH HART DEVICES

### Connecting to a HART Device

The 475 Field Communicator can communicate with a device from the control room, on the bench, or any wiring termination point in the loop. Connect the 475 Field Communicator with the appropriate connectors in parallel with the device or load resistor. The HART connectors are not polarity sensitive.

A minimum of 250 ohms resistance must be present in the HART loop for the 475 Field Communicator to function properly. For information about Intrinsically Safe connections, see Appendix B.

### HART Communication Terminals

Three terminals for the lead set are on the top of the 475 Field Communicator. Each red terminal is a positive connection for its protocol. The black terminal is a common terminal shared by both protocols. An access door ensures only one pair of terminals is exposed at any one time; see Figure 3-2. Several markings indicate which pair of terminals is for which protocol.

Figure 3-2. HART Communication Terminals and Access Door

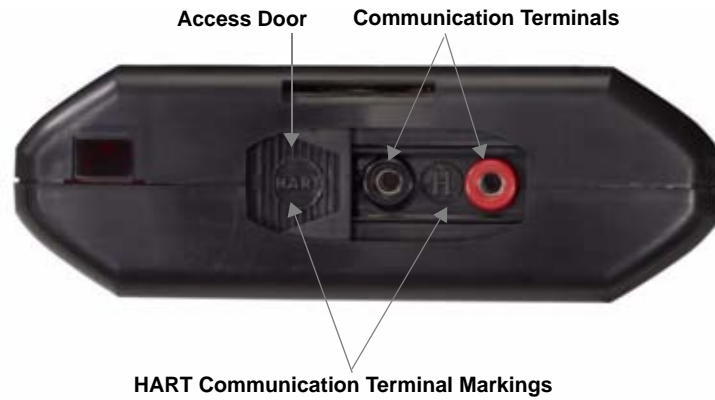

**NOTE**

The lead set must be used to communicate with a wired or wireless device. The 475 Field Communicator cannot communicate wirelessly with devices.

**Wiring Diagrams**

Figure 3-3 shows how to connect the 475 Field Communicator to a HART loop.

Figure 3-3. Connecting to a HART Loop

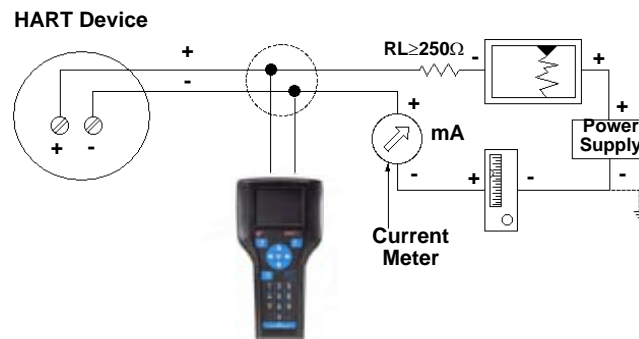

Figure 3-4 shows how to connect the 475 Field Communicator directly to the terminals of a HART device.

Figure 3-4. Connecting Directly to a HART Device

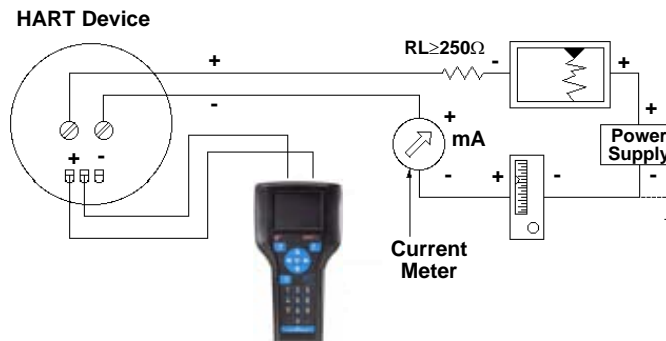
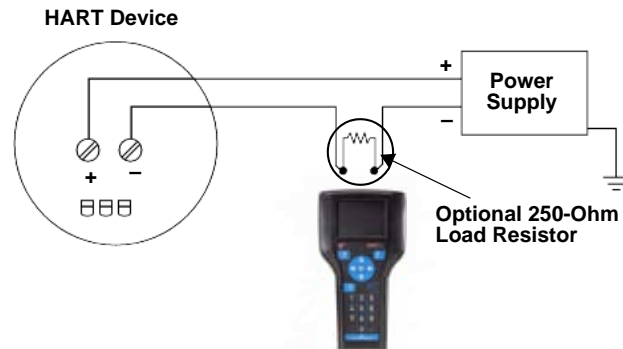

Figure 3-5 shows how to connect the optional 250 ohm resistor. Attaching a resistor is necessary if less than 250 ohms resistance is present in the HART loop.

Figure 3-5. Connecting with a 250 Ohm Resistor



To temporarily install the optional 250 ohm load resistor:

1. Insert the load resistor into the lead set jacks.
2. Open the loop to allow connection of the resistor in series in the loop.
3. Close the loop using the lead set connectors.

Figure 3-6 shows how to connect the 475 Field Communicator directly to the communication terminals on a wireless device.

Figure 3-6. Connecting to a wireless device

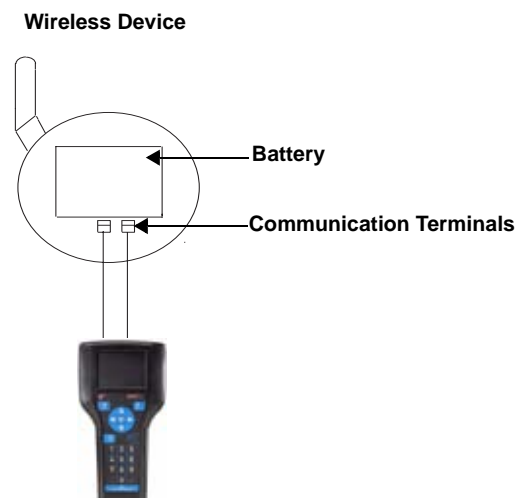



## Displaying the Connected HART Devices

After the device is connected, double-tap **HART Application** from the Field Communicator Main Menu. The HART Application automatically polls for connected devices using the selected polling options. See “Changing the HART Polling Options” on page 3-15 for information on modifying these options.

### NOTE

Communication errors, such as a device appearing at multiple addresses, can occur when polling addresses greater than 15 on a loop with both HART revision 5 or earlier and HART revision 6 or higher devices.

For many devices, an Online menu similar to Figure 3-7 is the first menu to appear when connected to a HART device and is the root menu for the device. This menu displays critical, up-to-date process information that is continuously updated, including device setup, primary variable (PV), analog output (AO), PV lower range value (LRV), and PV upper range value (URV). If a different Online menu appears, see your device documentation for details on the available menu options. The menus and configuration parameters for devices vary because they are defined in the device description. See your device documentation for more information.

### NOTE

Dynamic variables shown while online represent the digital data being sent from the device.

Figure 3-7. HART Online Menu Example

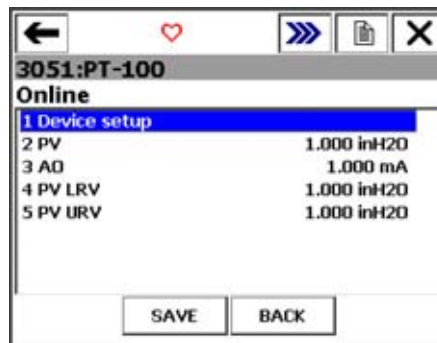





Because the Online menu displays important information, some submenus display the HOME button to return you to the HART Online menu.

## Interpreting the HART Icon

A beating HART icon appears at the top of the window when the 475 Field Communicator is communicating with a device. See the table below for the icons and their meanings.

Table 3-1. HART Icons

Icon	Meaning
	The 475 Field Communicator is communicating with a live, online HART device.
	The 475 Field Communicator is communicating with a HART loop with a device in burst mode.
	The 475 Field Communicator is running in shout/deaf mode, which helps the 475 communicate with a device when it is on a noisy loop.
	The 475 Field Communicator is running in shout/deaf mode and communicating to a HART loop with a device in burst mode.
	Communication is not occurring. This is common when only non-dynamic parameters are listed.

## Saving a Device Configuration

When you save a configuration from a connected device, it is saved as a device configuration.

To save the configuration in the connected device:

1. Ensure the 475 Field Communicator is connected to a HART loop or directly to the device and turn on the 475 Field Communicator.
2. Double-tap **HART Application** from the Field Communicator Main Menu. The HART Online menu appears.
3. Tap **Save**. The Save button will not appear if you have already saved the configuration while connected to the device. You may need to make a change to the configuration or disconnect and then reconnect to the device to resave.
  - a. To set the location where the configuration will be saved, double-tap **Location**, select an option, and tap **ENTER**.
  - b. To specify a name for the configuration, double-tap **Name**, enter the name, and tap **ENTER**.
4. Tap **Save**. If the configuration already exists, a message appears. Tap **YES** to overwrite the older version with the new version, or tap **NO** to return to the Save as window.

## Displaying Device Setup Options

The Device Setup on the HART Online menu accesses every configurable parameter for the connected device. Some devices may not display a Device Setup menu. Check your device documentation for more information. Double-tap **Device setup** to view the process variables, diagnostics and service, basic setup, detailed setup, and review menus.

### Process Variables

The Process Variables menu lists all process variables and their values. Process variables are continuously updated when this window is displayed.

### Diagnostics and Service

The Diagnostics and Service menu offers device and loop tests as well as calibration options. The diagnostics and service operations that are available vary widely from device to device and are defined in the device description.

The *Test device* menu lists the status as well as self and master test of the device. Test device initiates a diagnostic routine at the device and can report an electronics failure, as well as other failures that can affect performance.

*Loop test* is used to set the output of the device at a specified analog value, and may be used to test the integrity of the loop and the operation of indicators, recorders, or similar devices in the loop.

*Calibration* is used to perform such operations as performing a sensor trim, D/A trim, and scaled D/A trim.

### Basic setup

The Basic setup menu provides quick access to a number of configurable parameters including tag, unit, range values, and damping.

The options available in the Basic setup menu are the most fundamental tasks that can be performed with a device. These tasks are a subset of the options available under the Detailed setup menu.

The *Tag* identifies a specific device. Changing the unit option affects the engineering units that are displayed. Changing range values modifies the analog output scaling. Changing damping affects the response time of the transmitter and is often used to smooth the output when there are rapid input variations.

A modified parameter is highlighted yellow and an asterisk appears to indicate the change has not been sent to the device. Tap **Send** to update the device.

Figure 3-8. Modified Parameter Example

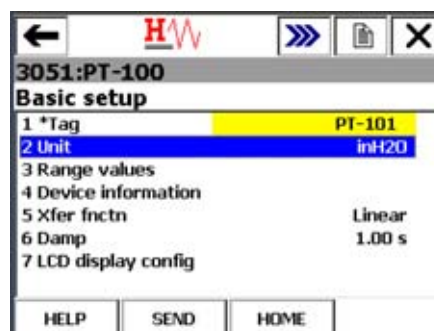

**Detailed setup**

The Detailed setup menu provides access to every editable device parameter and all device functions. The Detailed setup menu varies widely from one HART device to another. Functions in this menu can include tasks such as characterization, configuration, and sensor and output trims.

**Review**

The Review menu lists all of the static parameters read from the connected device, including information about the device and sensor setup and limitations. It also may include information about the connected device such as tag, materials of construction, and device software revision.

**Displaying Graphics**

The HART Application offers graphical views of device data by using the enhanced Electronic Device Description Language (EDDL) technology. Device data can be presented as images, charts, and graphs. These options appear as items in the HART Online menu and its submenus. The placement of the graphics in the menus varies from device to device because it is determined by the device manufacturer.

To view the graphical representations, you need a device using an enhanced device description. Only devices using an enhanced EDDL device description offer graphical representations of data. See Appendix C for more information about the Graphics functionality.

## CONFIGURING THE HART APPLICATION

### Using Hot Keys

#### Setting Up Hot Key Options

The Hot key menu is a user-definable menu that can store shortcuts for up to 20 of your most frequently performed tasks. For example, if you change device tags and damping often, you can add options for these functions to the Hot key menu for quick access. The Hot key automatically appears in the toolbar when you are working online. Hot keys created from generic DDs are not saved.

To add a custom option to the Hot key menu:

1. Connect to a HART device.
2. From the Field Communicator Main Menu, double-tap **HART Application**.
3. From the HART Online Menu or any of the submenus, select the option you want to add to the Hot key menu.
4. Tap and hold the Hot key (  ). The Hotkey Configuration window shows the new option you are adding.
5. Tap **ADD**.
6. Tap **ALL** to add the Hot key option for all device types, or tap **ONE** to add the Hot key option for only the device type to which you are currently connected.
7. If the message "Mark as read only variable on hotkey menu" appears, choose one of the following:
  - **YES**: The variable for this option is read-only. You can view but not change its value.
  - **NO**: You can view and change the value for this variable.
8. Respond to the message "Display value of variable on hotkey menu?" by choosing one of the following:
  - **YES**: The value of this variable appears on the Hot key menu.
  - **NO**: The Hot Key menu shows the name of the variable but not its value.
9. Tap the **EXIT** button on the Hotkey Configuration window to return to the original menu. The new option is added to the Hot key menu.

#### Using a Hot Key Option

You can access the Hot key menu from any online window.

To use a Hot key option:

1. Connect the 475 Field Communicator to a HART loop or device.
2. From the Field Communicator Main Menu, double-tap **HART Application**.
3. Tap the Hot key (  ) from an online menu.
4. Double-tap the desired option from the Hot key menu.

---

### Removing a Hot Key Option

To remove individual Hot key options:

1. Tap and hold the Hot key (  ). The Hotkey Configuration window appears.
2. Tap the menu option you want to remove.

---

#### NOTE

Some options are predefined and cannot be removed from the Hot key menu. These options vary depending on the device type.

---

3. Tap **DEL**.
4. When you are done, tap **EXIT** to close the Hotkey Configuration window.

### Removing all Hot Key Options

To remove all Hot key options currently defined:

1. From the HART Application main menu, double-tap **Utility**.
2. Double-tap **Configure HART Application**.
3. Double-tap **Storage Cleanup**.
4. Double-tap **Hotkey Menu**.
5. Tap **YES** if you are sure you want to delete all the items from the Hot key menu. Tap **NO** to return to the Storage Cleanup menu.

## Changing the HART Polling Options

Use the HART Polling Options to configure your 475 Field Communicator to automatically search for all or specific connected devices. Most HART device installations contain one device per loop and the device address is zero. Refer to your device manual for more information about changing a device polling address.

To have more than one device per loop, wire the devices in parallel and place into “Multidrop” mode. This mode is enabled by changing the address from zero to any address between 1-63. After the mode is enabled, the analog output of each device is fixed and no longer represents any variable.

---

### NOTE

Communication errors, such as a device appearing at multiple addresses, can occur when polling addresses greater than 15 on a loop with both HART revision 5 or earlier and HART revision 6 or higher devices.

---

To change the polling option:

1. From the HART Application main menu, double-tap **Utility**.
2. Double-tap **Configure HART Application**.
3. Double-tap **Polling Options**. Select one of the following polling options:
  - **Poll By Address** - Lets you poll for devices at the specified addresses. Tap **Enter** and then double-tap **Polling Addresses** from the Configure HART Application window to select addresses to poll. (This option appears only when Poll By Address is selected.) Select one of the following options from the Polling Addresses menu:

Table 3-2. Options in the Polling Addresses Menu

Polling Addresses	Recommended Use
0	Poll non multi-dropped loops.
0-15	Poll HART 5 or earlier devices on multi-dropped loops.
0-63	Poll HART 6 or newer devices on multi-dropped loops.
63	Poll the default address for WirelessHART adapters.
Custom Range	Poll a unique or non-consecutive group of addresses (example: “0, 5-7, 12”). Use a hyphen to specify consecutive addresses and/or a comma to separate numbers or groups of numbers.

- **Poll Using Tag** - Lets you enter and poll by the tag of the device. You are prompted to enter a tag when the HART Application starts.
  - **Poll Using Long Tag** - Lets you enter and poll by the long tag of the device. (Only supported in HART revision 6 or higher devices.) You are prompted to enter a tag when the HART Application starts.
  - **Poll Using Unique ID** - Lets you poll using the device’s unique ID. For HART revision 7 devices, the unique ID is the expanded device type, a hyphen, and the device ID. For HART revision 6 and earlier devices, the unique ID is the manufacturer ID, the device type, a hyphen, and the device ID. You are prompted to enter a unique ID when the HART Application starts.
4. Tap **Enter**.

## Ignoring Status Messages

The 475 Field Communicator displays status messages from the connected HART device. The Ignore Status option lets you specify the number of device status messages that are not displayed, extending the time between displayed messages. The default is 50 messages and it is reset to this value after you close the HART Application.

### NOTE

If you choose to ignore all device status messages, every message, regardless of severity, is ignored until the specified number of messages is reached.

To change the number of ignored status messages:

1. From the HART Application main menu, double-tap **Utility**.
2. Double-tap **Configure HART Application**.
3. Double-tap **Ignore Status**.
4. Enter the number of status messages you want ignored before the next message appears. You can specify a number from 50 to 500.
5. Tap **ENTER**. All device status messages are ignored until the quantity specified is reached.

## Changing the Menu Title for HART Revision 6 or Higher Devices

The HART 6 Tag menu lets you select the HART short or long tag to display in the menu title for HART revision 6 or higher devices. The short tag can have up to 8 characters, and the long tag can have up to 32 characters. These tags can be edited at any time. If the long tag does not fit on the window, an ellipsis is shown at the end of the tag. Tap and hold the ellipsis to see the full tag name.

The location of these parameters in the Online menu varies from device to device because it is determined by the device manufacturer.

To select a HART tag for the menu title:

1. From the HART Application main menu, double-tap **Utility**.
2. Double-tap **Configure HART Application**.
3. Double-tap **HART 6 Tag**.
4. Tap **Show Long Tag** to display the HART long tag, or tap **Show Short Tag** to display the HART short tag.
5. Tap **ENTER**. The 475 Field Communicator continues to use the option you selected until you change the setting.

## Storage Cleanup

The Storage Cleanup menu lets you delete the following items:

- **Internal Flash** - Tap **YES** to delete all configurations in the Internal Flash. Tap **No** to cancel.
- **System Card** - Tap **YES** to delete all configurations in the System Card. Tap **No** to cancel.
- **Hotkey Menu** - Tap **YES** to delete all items from the Hot key menu. Tap **No** to cancel.





## Viewing Available Device Descriptions

The Available Device Descriptions menu lets you view all the device descriptions in the 475 Field Communicator. HART device descriptions enable the 475 Field Communicator to recognize and configure specific HART devices. Use the Field Communicator Easy Upgrade Utility to download or import new device descriptions and then transfer them to your 475 Field Communicator. See the Easy Upgrade Utility Help more information.

To view the currently installed HART device descriptions:

1. From the HART Application main menu, double-tap **Utility**.
2. Double-tap **Available Device Descriptions**. The manufacturer names of the installed device descriptions are listed.
3. Double-tap the desired device manufacturer to expand the list. The models available for the manufacturer are listed.
4. Double-tap the desired device model. The device revisions available for the selected model are listed. One of the icons below appears next to each device description to indicate its status.

Table 3-3. Device Description Icons

Icon	Meaning
	The device description has been tested with the system software version in the 475 Field Communicator.
	The device description has not been formally tested for use with the system software version in the 475 Field Communicator. The device description can be used, but you may experience unexpected results.
	The device description is incompatible and cannot be used with the system software version in the 475 Field Communicator. You need to transfer a different version of this device description to the 475 Field Communicator.

## Simulating an Online Connection to a HART Device

The 475 Field Communicator has a simulation mode that lets you simulate an online connection to a HART device without actually connecting to a device. Simulation mode is a training tool that helps you become familiar with devices before configuring them in a critical environment. A simulated configuration cannot be saved. Not all device descriptions have been optimized to run under simulation. The HART Application will close to the Field Communicator Main Menu if the device cannot be simulated.

To simulate a connection to a HART device:

1. From the HART Application main menu, double-tap **Utility**.
2. Double-tap **Simulation**. The manufacturers with device descriptions installed in the 475 Field Communicator are listed.
3. Double-tap the desired manufacturer to expand the list. The models available for the manufacturer are listed.
4. Double-tap the desired model to expand the list. The device revisions available for the selected model are listed.
5. Double-tap the desired device revision. Refer to the device manual to determine the device revision.
6. If a warning appears, thoroughly read the warning, tap **CONT** to accept the warning and proceed, or tap **EXIT** to return to the Utility menu. (This warning does not appear if your device is tested.) The Online menu for the simulated device appears. You can now use the 475 Field Communicator as if it were connected to the selected device and perform any online task.

---

## RUNNING HART DIAGNOSTICS

### DC Voltage Measurement (HART Terminals)

The HART DC voltage measurement takes a voltage reading at the HART connector and displays it in the window.

To check the device voltage:

1. From the HART Application main menu, double-tap **HART Diagnostics**.
2. Double-tap **DC Voltage Measurement**. The DC voltage measurement appears.
3. Tap **OK** when you are finished viewing the measurement. To refresh the window, double-tap **DC Voltage Measurement** from the HART Diagnostics menu.

---

 **CAUTION**

Voltage measurements are for reference purposes only. Do not make critical process control decisions based upon these measurements.

---

### DISCONNECTING FROM A HART DEVICE

Prior to disconnecting the 475 Field Communicator from a HART device, check the following items:

- Determine if you want to save a configuration.
- Verify methods, such as calibration or loop test, are complete.
- Resolve any un-sent data to the device.

## SECTION 4

## FIELDBUS FUNCTIONALITY

### OVERVIEW

This section provides instruction on basic fieldbus functionality in the 475 Field Communicator. It is based on the operation of the FOUNDATION Fieldbus Application version 5.0.

### SAFETY MESSAGES

Procedures and instructions in this section may require special precautions to ensure the safety of the personnel performing the operation. Information that raises potential safety issues is indicated by a warning symbol () . Refer to the safety messages before performing an operation preceded by this symbol. Other warning messages can be found in the Troubleshooting section of this manual.

#### WARNING

If a segment is connected to a host system, the changes made with the 475 Field Communicator may not be recorded in the host system's permanent database. Verify the changes in the database. Otherwise, this could cause unpredictable results and, depending upon your application, process disruption leading to property damage, serious injury, or death. Ensure all safety precautions and work procedures have been followed.

#### WARNING

Changing device parameters could adversely affect the control of your process. Put the control loop in Manual/Out of Service before applying changes. Verify the output before returning the control loop to Auto. Failure to do so could result in property damage, serious injury, or death. Ensure all safety precautions and work procedures have been followed.

#### WARNING

The 475 Field Communicator draws approximately 12 mA from the fieldbus segment. Be sure the power supply or barrier on the fieldbus segment has the capacity to provide this additional current. If a heavily loaded fieldbus segment is drawing near the capacity of the segment's power supply, connecting the 475 Field Communicator may result in loss of communication.

## **BASIC FEATURES AND FUNCTIONS**

### **Fieldbus Application Functionality**

The Fieldbus Application lets you communicate with connected fieldbus devices, modify settings for the application, and run diagnostics. Your 475 Field Communicator must be licensed for FOUNDATION Fieldbus to run this application. See your sales representative or the Online Licensing feature in the Field Communicator Easy Upgrade Utility to purchase this license.

### **Link Active Scheduler (LAS)**

All segments have only one Link Active Scheduler (LAS). The LAS operates as the bus arbiter for the segment. The 475 Field Communicator is set up to always be the last node to become the LAS on a segment.

The devices that are capable of becoming the LAS are called link master devices. All other devices are referred to as basic devices. When a segment first starts up, or upon failure of the existing LAS, the link master devices on the segment bid to become the LAS. The link master that wins the bid (the one with the lowest address) begins operating as the LAS immediately upon completion of the bidding process. Link masters that do not become the LAS can act as LAS backups by monitoring the segment for failure of the LAS and then bidding to become the LAS when a LAS failure is detected.

Although the 475 Field Communicator is capable of becoming the LAS, it does not maintain the communication schedule and should not be thought of as a backup LAS.

Only one device can communicate at a time. Permission to communicate on the bus is controlled by a centralized token passed between devices by the LAS. Only the device with the token can communicate. The LAS maintains a list of all devices that need access to the bus. This list is called the Live Device List; see “Displaying the Connected Fieldbus Devices” on page 4-7.

### **LAS Hierarchy**

When a 475 Field Communicator is connected to a live fieldbus segment, it joins the fieldbus segment but not as the LAS. This means the 475 Field Communicator can view and edit device parameters, but the control of the segment is still handled by the node that is designated the LAS for the segment. You can also read and write if there is another LAS. Prior to connecting to a host system, review the 475 Field Communicator Host System Interoperability on [www.fieldcommunicator.com](http://www.fieldcommunicator.com).

## STARTING THE FOUNDATION FIELDBUS APPLICATION

A general warning message may appear upon starting the Fieldbus Application when a LAS is detected on the segment. Tap **YES** to go to the Live Device List, **NO** to return to the Field Communicator Main Menu, or **HELP** to get more information on the warning.

To start the Fieldbus Application:

1. Press and hold the Power Key until the green light on that key blinks to turn on the 475 Field Communicator.
2. Double-tap **FOUNDATION Fieldbus Application** from the Field Communicator Main Menu. If a live fieldbus device is connected to the 475 Field Communicator, the Fieldbus Application main menu briefly appears followed by the Live Device List. Figure 4-1 shows the Fieldbus Application main menu.

If insufficient voltage is detected, a warning message appears. Tap **OK** to go to the Fieldbus Application main menu.

Figure 4-1. Fieldbus Application Main Menu

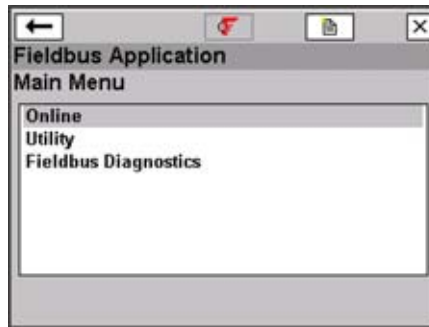

A connection warning message may appear if no communication is detected. This means that a LAS is not recognized by the 475 Field Communicator. This typically occurs when connecting to a single device.

To go back to the Field Communicator Main Menu, tap the back arrow button or press the left arrow key on the keypad.

From the Fieldbus Application main menu, you can choose Online, Utility, or Fieldbus Diagnostic functions. The rest of this section guides you through the Fieldbus Application menus and functions.

## WORKING ONLINE WITH FIELDBUS DEVICES

The online menu display data for the device to which you are connected, and they display critical, up-to-date process information, including the segment Live Device List, Block Lists, device menus, and parameter information.

---

### NOTE

It is normal for processes to take longer the greater the amount of scheduled communication. This is influenced by the number of devices and the control methods in place.

---

## Connecting to a Fieldbus Device

Connect the 475 Field Communicator by using the lead set with the appropriate connectors in parallel with the device. Due to measurement circuitry, the 475 Field Communicator fieldbus connectors on the communication terminals are polarity sensitive. An error message appears if the lead set is connected incorrectly.

For information about Intrinsically Safe connections, see Appendix B.

---

### NOTE

Dynamic variables shown while online represent the digital data being sent from the device.

---

Digital communication is susceptible to electrical noise; follow proper wiring instructions.

### Fieldbus Communication Terminals

Three terminals for the lead set are on the top of the 475 Field Communicator. Each red terminal is a positive connection for its protocol. The black terminal is a common terminal shared by both protocols. An access door ensures only one pair of terminals is exposed at any one time; see Figure 4-2. Several markings indicate which pair of terminals is for which protocol.

Figure 4-2. Fieldbus Communication Terminals and Access Door

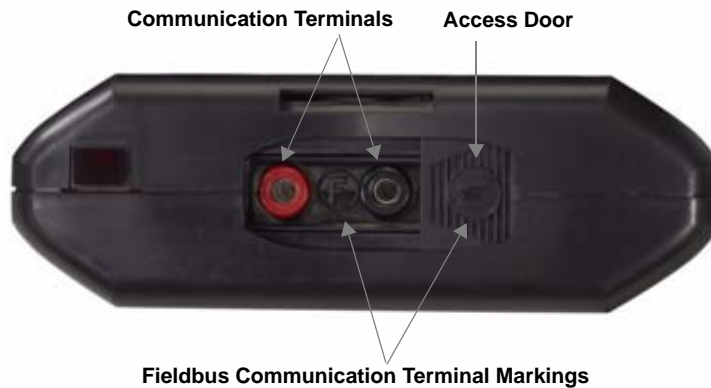

**Bench Hook-Up**

Figure 4-3 illustrates one method of connecting the 475 Field Communicator on a bench.

For segments that are limited in size, the power conditioner and terminators can be contained in a single wiring block.

Figure 4-3. Bench Wiring Diagram Example

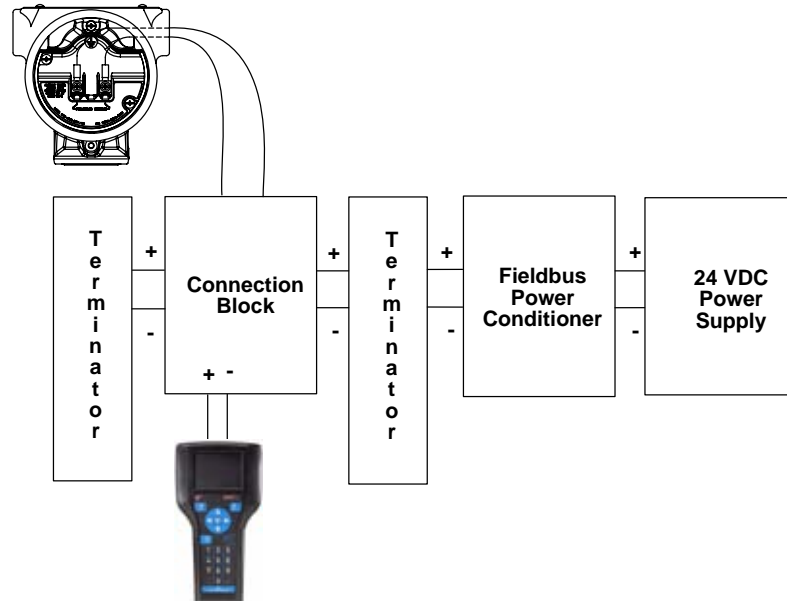

### Field Hook-Up

Figure 4-4 illustrates one method of connecting the 475 Field Communicator to a fieldbus segment. The 475 Field Communicator can be connected at any convenient place along the bus (segment). In the field, this is typically done at the device or at the fieldbus junction box.

Figure 4-4. Field Wiring Diagram Example

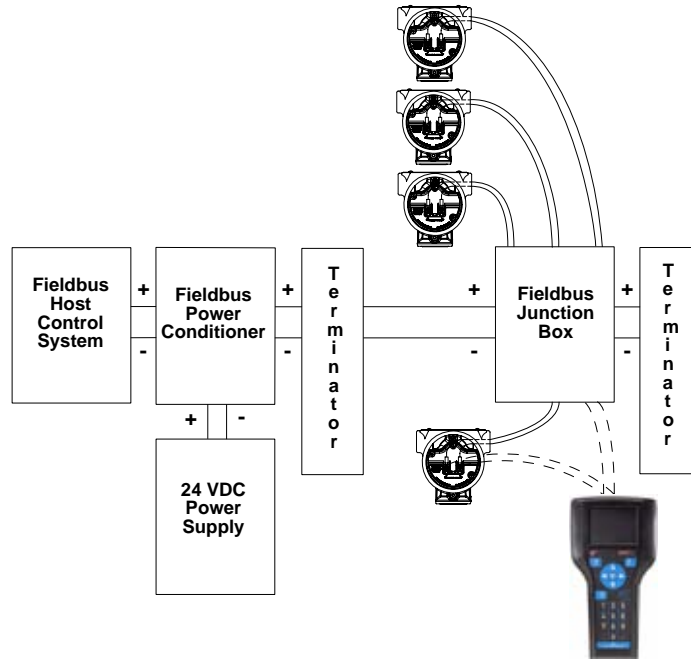

### ⚠ CAUTION

The 475 Field Communicator draws approximately 12 mA from the fieldbus segment. Ensure the power supply or barrier on the fieldbus segment has the capacity to provide this additional current. If a fieldbus segment is drawing near the capacity of the segment's power supply, connecting the 475 Field Communicator may result in loss of communication.



## Displaying the Connected Fieldbus Devices

To display the connected devices on a fieldbus segment (Live Device List):

1. Connect the 475 Field Communicator to a fieldbus segment.
2. Turn on the 475 Field Communicator.
3. On the Field Communicator Main Menu, double-tap **FOUNDATION Fieldbus Application**.
4. On the Fieldbus Application main menu, double-tap **Online**. The Fieldbus Live Device List appears and indicates which device or host is acting as the LAS. The text *LAS* appears at the top of the window only when the 475 Field Communicator is the LAS. See Figure 4-5.

If a live fieldbus device is connected to a host acting as the LAS, a precautionary message appears. The Live Device List then appears with the tag name and address for the connected device.

If an existing host control system or a device capable of being the LAS is not connected, the 475 Field Communicator acts as a temporary LAS on the segment and produces a warning message. After reading and following the message instructions, tap **OK** to display the Live Device List.

From the Live Device List, a Block List or a device menu is displayed for a device, depending on the device description.

Figure 4-5. Live Device List Window Example

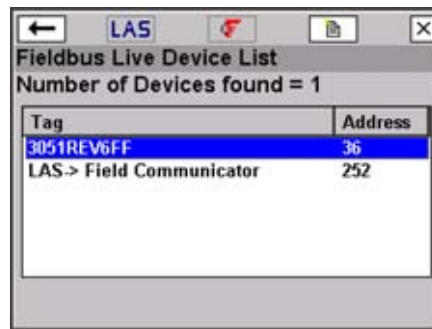

Tag	Address
3051REV6FF	36
LAS-> Field Communicator	252

### Displaying the Device Blocks

The Block List displays the block tag, block type, and actual mode of the device blocks in the connected device. It also lists an Advanced menu with additional menu options. Consult your device manual or the Fieldbus Foundation for more information on blocks and their functionality. FOUNDATION fieldbus menu trees are on [www.fieldcommunicator.com](http://www.fieldcommunicator.com) as they become available.

To view the Block List:

1. From the Fieldbus Application main menu, double-tap **Online**.
2. Double-tap a device. The Block List appears.

Figure 4-6. Block List Example



### Displaying a Device Menu

Some devices, depending on their device descriptions, display a device menu rather than the Block List. A device menu displays the same parameters as the Block List, but they are organized by function rather than by block. Options such as Overview, Configure, Service Tools, and Advanced may appear. The Block List is still accessible from the Advanced option in a device menu.

The menu items displayed in the device menu vary because they are determined by the device description. Refer to your device manual or [www.fieldcommunicator.com](http://www.fieldcommunicator.com) for menu trees.

To view a device menu:

1. From the Fieldbus Application main menu, double-tap **Online**.
2. Double-tap the device. The device menu appears.

## Block Modes

The resource, transducer, and all function blocks in the device have modes of operation. These modes govern the operation of the block. Every block supports both automatic (AUTO) and out of service (OOS) modes. Other types of modes that may also be supported are Cas, RCas, ROut, IMan and LO.

### Types of Modes

For the procedures described in this manual, it is helpful to understand the following modes:

#### **AUTO**

The functions performed by the block will execute. If the block has any outputs, these will continue to update. This is typically the normal operating mode.

#### **MAN**

In this mode, the output of the block can be manually overwritten for testing purposes.

#### **Out of Service (OOS)**

The functions performed by the block will not execute. If the block has any outputs, these will typically not update and the status of any values passed to other blocks is "BAD". Before you make changes to the configuration of the block, change the mode of the block to OOS. When the changes are complete, change the mode back to AUTO.

### Mode Parameters

Mode parameters are used to change the block mode from one state to another. There are four types of mode parameters: Target, Actual, Permitted, and Normal.

The Target mode is the mode assigned to a block and is used to change a block to a desired mode.

The Actual mode is the current mode of the block.

The Permitted mode lists the modes that are allowed for a block. Setting the Permitted modes prevents unauthorized changes to the operating mode of a block. To do this, configure the Block:Mode Permitted parameter to allow only the desired operating modes. It is recommended to always select OOS as one of the Permitted modes.

The Normal mode is the mode the block should be set to during normal operation conditions.

### Locate Mode Parameters

In the resource and transducer blocks, the mode parameters are normally found in the Process menu. In all other function blocks, they are found in the Common Config menu. The mode parameters are also included in the All parameter list; see "Device Blocks" on page 4-11.

You can view and edit the Target mode parameter by tapping the **MODE** button in the menus.

### Change Modes

Whenever you need to change the parameters or properties of a block, you need to change the mode. A warning message may appear if the mode of any block is included in a list of parameter changes to be sent to a device.

To change the block mode:

1. Tap the **MODE** button in the Block Menu or device menu. See Figure 4-7.
2. If prompted, select a block from the list and tap **OK**.
3. Remove the checkmark next to the current mode by tapping the checkbox next to it. An asterisk (\*) symbol appears next to Block Mode Target and the checkboxes are highlighted yellow to indicate the change to the Target mode has not been sent to the device. If the mode checkboxes are read-only, the block may have been set to allow only one mode.
4. Tap the checkbox next to a mode to select it as the new Target mode.
5. Tap **OK**.
6. When the message appears, tap **YES** to apply and send the change to the device, or tap **NO** to cancel. A Mode Change window showing the Target mode and Actual mode appears until the Actual mode changes. If the window does not disappear, the actual mode cannot be changed due to the current device state. Tap **CLOSE** to close the Mode Change window.

Figure 4-7. Device Block Menu and Mode window

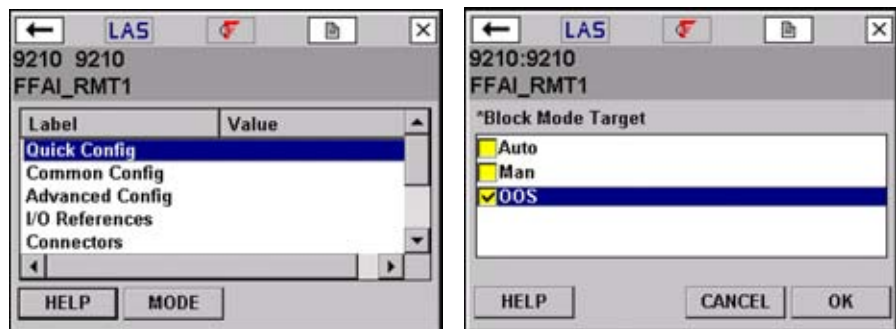

## Device Blocks

The Block Menu is a submenu of the Block List and it displays block information for the fieldbus device to which you are connected. The Block Menu is also available from the Advanced option in a device menu.

Devices that do not support transducer block menus within the device description have the following selections: All, Process, Status, Other.

If methods are incorporated into the transducer block, they may be displayed as either Diagnostic Methods or Calibration Methods.

Tap **All** to display all of the parameters for the desired block. It may take several minutes to display the parameters. It is recommended that you use this only if you are unable to find your desired selection elsewhere.

### Displaying the Block Menu

If the device description supports menus, you can display the Block Menu by performing the following steps:

1. From the Live Device List, double-tap a device to display the Block List. See page 4-8. For device menus, the Block List is available from the Advanced menu.
2. Double-tap the desired block tag.
3. From the Block Menu, double-tap the desired parameter group.

---

### NOTE

The Block mode must be in the appropriate state to accept parameter changes. Typically, the mode is MAN or OOS.

---

### Displaying Parameters

To display the parameters for fieldbus devices:

1. Display the Live Device List; see page 4-7.
2. Double-tap a device.
3. Double-tap the desired block from the Block List or the appropriate item from a device menu.
4. Double-tap the desired parameter group. The parameters and their current values appear.

### Changing and Sending Parameter Data

Shaded areas in a menu indicate values that cannot be changed. You can edit only the resource, transducer, and I/O blocks. You can open and view all other blocks, however, you cannot edit them.

When you modify a parameter value, an asterisk (\*) appears and the value is highlighted yellow to indicate the change has not been sent to the device.

---

### CAUTION

Changing device parameters could adversely affect the control of your process. Put the control loop in Manual/Out of Service before applying changes. Verify the output before returning the control loop to Auto. Failure to do so could result in property damage, serious injury, or death. Ensure all safety precautions and work procedures have been followed.

---

To change the values for parameters:

1. Display the parameters for the device.
2. Double-tap the desired parameter.
3. Change the value for the parameter. (Tap **HELP** to view a description of the parameter.)
4. Tap **OK**. Repeat these steps for other parameters as necessary.
5. Tap **SEND** to commit your changes to the connected device. After you click SEND, the modified values are no longer highlighted yellow.

### **Displaying the Status of a Block**

Different devices have different options associated with them and the selections on these menus vary accordingly. See your device documentation for more information on supported menu items.

To display device status:

1. Display the Live Device List; see page 4-7.
2. Double-tap a device.
3. Double-tap the desired block.
4. Double-tap **Status**. Status parameters appear.

### **Running Methods**

Different devices have different methods associated with them, and the selections on these menus vary accordingly. See your device documentation for more information on supported menu items.

To run methods:

1. Display the Live Device List; see page 4-7.
2. Double-tap a device.
3. Double-tap the desired block (typically, methods are run in the transducer block).
4. Double-tap a menu containing methods. The menu option will vary for each device.
5. Double-tap the type of method you want to run, for example, calibration or diagnostic. Follow the prompts on the windows to run the method.

---

## Displaying Device Information

---

### NOTE

The physical device tag and address of a device are read-only when, at a minimum, any of the following hosts/linking devices are detected on the segment: Rosemount 3420, DeltaV, Ovation, Allen-Bradley, Honeywell Experion PKS, or Yokogawa Stardom. To change the device tag or address, use the host system or remove the device from the segment and connect it directly to the 475 Field Communicator.

---

To display the Physical Device Tag, Device Address, Device ID, and the Device Revision:

1. Display the Live Device List; see page 4-7.
2. Double-tap a device.
3. Double-tap **Advanced**.
4. Double-tap **Detail**. Double-tap one of the following options:
  - **Physical Device Tag** designates a device's identity in the system.
  - **Address** is the data link layer node address of the device. The host control system has the ability to assign an address to a device when it is connected to a segment. When assigning device addresses, follow the guidelines below:
    - Valid device addresses for fieldbus devices are 20 through 247 with the exception of the addresses between V(FUN) and V(FUN) + V(NUN)-1 parameters as defined for the 475; see "Changing the Fieldbus Polling Addresses" on page 4-16. These parameters are available in the Polling menu.
    - Addresses between 16 and 19 are usually reserved for host systems. A device should **not** be assigned in this address range.
    - Addresses below 16 are not available.
    - Addresses between 248 and 251 are temporary addresses. Devices without a tag or address appear on the segment at these addresses.
    - Addresses in the range 252 to 255 are reserved for visitors, such as the 475 Field Communicator.
  - **Device ID** is the unique number identifier for each device. It is set by the device manufacturer and cannot be changed.
  - **Device Revision** is the manufacturer revision number. It is used by an interface device to locate the device description and cannot be changed.
5. Using the SIP keyboard, enter the new information. When you modify a parameter value, an asterisk (\*) appears and the value is highlighted yellow to indicate the change has not been sent to the device.
6. Tap **OK**.
7. Tap **SEND** to send the changes to the device. A window appears until the changes are made.
8. Tap **YES**, if prompted.

---

### Displaying Network Settings

To view the network parameters for the device or segment:

1. Display the Live Device List; see page 4-7.
2. Double-tap a device.
3. Double-tap **Advanced**.
4. Double-tap **Network Management**.
5. Double-tap the desired label to view the values.

Tap the **SAVE** button to save this as a text file. Connect your 475 Field Communicator to the Field Communicator Easy Upgrade Utility to transfer this file to a PC. The file appears in the User Data tab.

### Changing the I/O Block Schedule

Changing the I/O Block Schedule is typically done on the bench (not connected to a control system) when you want to execute an I/O block to verify that the outputs of the block are computed correctly.

---

#### NOTE

You cannot schedule I/O blocks when, at a minimum, any of the following hosts/linking devices are detected on the segment: Rosemount 3420, DeltaV, Ovation, Allen-Bradley, Honeywell Experion PKS, or Yokogawa Stardom. To schedule I/O blocks, use the host system or remove the device from the segment and connect it directly to the 475 Field Communicator.

---

To change the schedule:

1. Display the Live Device List; see page 4-7.
2. Double-tap a device.
3. Double-tap **Advanced**.
4. Double-tap **Schedule**. The I/O Block Schedule window appears.
5. Select the appropriate MacroCycle from the drop-down list.
6. Tap the appropriate checkboxes next to the I/O blocks.
7. Tap **OK**. This schedules the blocks and sets the block mode to Auto.
8. After reading the note, tap **OK** to acknowledge that the I/O blocks were successfully scheduled.

### Instantiating Blocks

The Instantiate Block menu lets you add function and transducer blocks to a connected device. This menu item appears only if the fieldbus device contains instantiable block types. After a block has been instantiated, the view displays the new block. The Actual mode of the new instantiated block is set to OOS.

---

#### NOTE

You cannot instantiate or delete blocks when, at a minimum, any of the following hosts/linking devices are detected on the segment: Rosemount 3420, DeltaV, Ovation, Allen-Bradley, Honeywell Experion PKS, or Yokogawa Stardom. To instantiate or delete blocks, use the host system or remove the device from the segment and connect it directly to the 475 Field Communicator.

---



To instantiate a block:

1. Display the Live Device List; see page 4-7.
2. Double-tap a device.
3. Double-tap **Advanced**.
4. Double-tap **Instantiate Block**.
5. Tap the type of block that you want to add to the device.
6. Tap **OK** to add the block to the device. Tap **CANCEL** to exit the window without adding a block.
7. When the warning message appears, tap **YES** to instantiate the block, or **NO** to cancel the operation.

### Deleting Instantiated Blocks

The Delete Block menu lets you delete instantiated blocks from a fieldbus device; you cannot delete permanent blocks. You can delete only one instantiated block at a time, and the Actual mode in the device must be set to OOS. If the Delete Block menu item is selected and no blocks have been instantiated in the device, an error message appears. After a block has been deleted, the window is refreshed and it does not display the deleted block.

To delete an instantiated block:

1. Display the Live Device List; see page 4-7.
2. Double-tap a device.
3. Double-tap **Advanced**.
4. Double-tap **Delete Block**.
5. Tap the block that you want to delete from the device.
6. Tap **OK**.
7. When the warning message appears, tap **YES** to delete the block, or **NO** to cancel the operation.

---

### NOTE

Some devices restart after a block is instantiated or deleted, causing a loss in communication between the 475 Field Communicator and the device. After the device and 475 Field Communicator resume communication, the Live Device List appears.

---

## Displaying Graphics

The FOUNDATION Fieldbus Application offers graphical views of device data by using the enhanced Electronic Device Description Language (EDDL) technology. Device data can be presented as images, charts, and graphs. These options appear as items in the Online menu and its submenus. The placement of the Graphics options in the menus varies from device to device because it is determined by the device manufacturer.

To view the graphical representations, you need a device using an enhanced device description. Only devices using an enhanced EDDL device description offer graphical representations of data. See Appendix C for more information about the Graphics functionality.

## CONFIGURING THE FOUNDATION FIELDBUS APPLICATION

### Changing the Fieldbus Polling Addresses

Polling is a method of determining which devices are present on a network. The V(FUN) is the first unpolled node address. V(NUN) is the number of unpolled node addresses. The addresses between V(FUN) and V(FUN)+V(NUN)-1 are not polled. The default value for V(FUN) is 200 and the default value for V(NUN) is zero. Narrowing the range of devices being polled provides a quicker Live Device List refresh.

The DeltaV System Polling checkbox instructs the 475 Field Communicator to use the same polling scheme as DeltaV. The V(FUN) and V(NUN) options are read-only when the checkbox is selected.

To change the polling addresses:

1. From the Fieldbus Application main menu, double-tap **Utility**.
2. Double-tap **Polling**.
3. Enter values in the V(FUN) and V(NUN) fields and tap **OK**.

### Changing the Slot Time

Select the default Slot Time of 8 to allow the devices to be seen on the 475 Field Communicator Live Device List. From the Fieldbus Application Utility main menu, double-tap **Utility** and then double-tap **Link Settings** to access the Slot Time menu. It may be necessary to change the Slot Time to 16 to view older devices on the 475 Field Communicator Live Device List.



### Viewing Available Device Descriptions

The Available Device Description List menu lets you view all the device descriptions in the 475 Field Communicator. Fieldbus device descriptions enable the 475 Field Communicator to recognize and configure fieldbus devices. Use the Field Communicator Easy Upgrade Utility to download or import new device descriptions and then transfer them to your 475 Field Communicator. See the Easy Upgrade Utility Help for more information.

To view the fieldbus device descriptions installed in the 475 Field Communicator:

1. From the Fieldbus Application main menu, double-tap **Utility**.
2. Double-tap **Available Device Description List**. The manufacturer names of the installed device descriptions are listed.
3. Double-tap the desired device manufacturer to expand the list. The models available for the manufacturer are listed.
4. Double-tap the desired device model. The device revisions available for the selected model are listed. One of the following icons appears next to each device description to indicate its status.

Table 4-1. Device Description Icons

Icon	Meaning
	A tested device description can be used with the system software version in the 475 Field Communicator.
	An untested device description has not been formally tested for use with the system software version in the 475 Field Communicator. The device description can be used, but you may experience unexpected results.
	An incompatible device description cannot be used with the system software version in the 475 Field Communicator. You need to transfer a different version of this device description to the 475 Field Communicator.

## RUNNING FIELDBUS DIAGNOSTICS

The Fieldbus Diagnostics menu lets you run diagnostics to troubleshoot fieldbus networks and devices. You can check the DC voltage, the noise level at low frequencies, and the signal level and communication status. The selected tests are automatically repeated and the test results are updated in the Diagnostics Results window.

To view the values associated with the status indicators or the possible causes of the values, run the diagnostic test, highlight the test on the Diagnostics Results window, and tap **HELP**.

### DC Voltage Measurement

The DC voltage test displays the amount of DC voltage on a segment. The word **Limit** appears if the DC voltage measurement is out of the -37 V to 37 V range. If the DC voltage is out of this range, there may be a faulty terminator, wiring problem, or power supply problem.

This test displays the measurement value, measurement unit, and one of the status indicators listed below.

**OK** - The value is within the acceptable range.

**High** - The value is greater than 32 V.

**Low** - The value is less than 9 V.

**Error** - There is an error in the measurement or within the 475 Field Communicator.

### Noise Level Measurement

The noise level test displays the amount of noise on the segment. The word **Limit** appears if the noise level measurement is greater than 1.0 V. If the low frequency noise is too high, the power supply or power conditioner may be faulty.

This test displays the measurement value, measurement unit, and one of the status indicators listed below.

**OK** - The value is within the acceptable range.

**High** - The value is greater than 75mv from peak to peak.

**Error** - There is an error in the measurement or within the 475 Field Communicator.

### Signal Level Measurement

The signal level test determines if a 475 Field Communicator can receive signals from devices on a segment. To measure the fieldbus signal level, make sure an LAS is on the segment. Up to 16 different nodes are checked. The word **Limit** appears if the signal level value is greater than 1.3 V. The word **Low** appears if the signal level value is less than 100 mV.

This test displays the node address, measurement value, measurement unit, and one of the status indicators listed below.

 - All signal responses from the device were received by the 475 Field Communicator.

**!** - One or more signal responses from the device was not received by the 475 Field Communicator. This may be caused by noise on the segment.

**X** - No signal responses from the device were received by the 475 Field Communicator. This may be caused by noise on the segment.

**Error** - The measurement value is less than 75 mV or there is an error within the 475 Field Communicator.

Figure 4-8. Fieldbus Diagnostics Window Examples

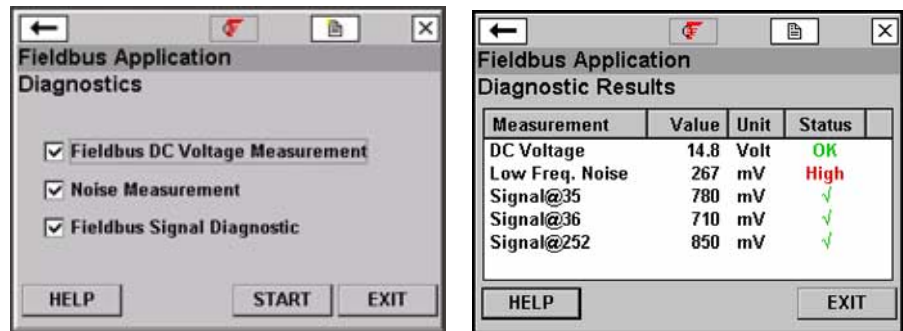

## DISCONNECTING FROM A FIELDBUS DEVICE

Prior to disconnecting or turning off the 475 Field Communicator, check the following items:

- Verify methods are complete.
- Resolve any un-sent data to the device.

## SECTION 5

## TROUBLESHOOTING

### OVERVIEW

This section provides basic troubleshooting techniques for the 475 Field Communicator.

Below are methods for troubleshooting networks that are experiencing problems communicating between a device and the 475 Field Communicator.

### Troubleshooting Suggestions

Answer the questions below and use the tables in this section before calling Technical Support personnel.

- Does the control system have HART or fieldbus communication capabilities?
- Is it configured to communicate HART or fieldbus?
- Is it reporting communication problems? If not, stop communications on the control system and re-test communication with the 475 Field Communicator.
- Is there a barrier installed?
- Is the barrier capable of passing along the signal?

#### HART Loops

Verify the HART loop current and voltage on the device. Almost all devices need at least 4 mA and 12V DC to operate properly.

If there are multiple devices on a multidrop loop, set the 475 Field Communicator to Poll by Address. See "Changing the HART Polling Options" on page 3-15 for more information on polling options.

Inspection of the loop wiring can often reveal problems. The shield is normally grounded at one end only, which is usually the control system.

Verify the loop has a minimum of 250 ohms resistance. If there is not an external resistor, then, normally, the total resistance is the resistance of the process-indicating device monitoring the loop. Check the manuals for the process-indicating device to determine its loop resistance. If the resistance of the process-indicating device is unknown, it can be determined by knowing the current flow in the loop and the voltage across the process-indicating device.

The resistance can be calculated using the formula, Resistance = Voltage / Current. The 475 Field Communicator can be used to measure the voltage; see "DC Voltage Measurement (HART Terminals)" on page 3-18.

---

**Sample Values**

Loop Current Flow Minimum voltage for 250 ohms.

4 mA 1 Volt

8 mA 2 Volts

12 mA 3 Volts

16 mA 4 Volts

20 mA 5 Volts

If the voltage across the process-indicating device is greater than the value listed for a given current flow, the device has at least 250 ohms of internal resistance. If the voltage is less than the value listed in the table for the given current flow, more resistance needs to be added to the loop.

If an oscilloscope is available, use it to look for noise on the loop. Use a scope with differential mode capability or a battery powered/isolated scope to avoid grounding one side of the loop. Noise with a frequency of 500 Hz to 10,000 Hz is of particular interest, as this represents frequencies near the HART frequencies of 1200 and 2200 Hz.

Table 5-1. Troubleshooting Table for the HART Protocol

Symptom	Possible Causes	Solution
Intermittent communication	Insufficient loop current and voltage at the device terminals.	Verify there is at least 4 mA and 12V DC at the device terminals; see “DC Voltage Measurement (HART Terminals)” on page 3-18.
	Noise on the field loop. Noise or signal distortion from the control system (i.e., noise from the power supply powering the devices or front end analog circuitry inside the control system may be distorting the HART signal.	
	Poor wiring.	Check wiring terminations and exposed signal wire for damage.
No communication with device.	Insufficient loop resistance at the HART frequencies.	Add an additional 250 ohm resistor in series in the loop. Place the leads across the resistor and verify if communication has been restored.
	Insufficient loop current and voltage at the device terminals.	Verify that there is at least 4 mA and 12V DC at the device terminals; “DC Voltage Measurement (HART Terminals)” on page 3-18.
	Device may be set to a HART address other than zero (multidrop mode).	Change Polling mode to Poll by Address. See “Changing the HART Polling Options” on page 3-15.
Cannot connect to a HART device	The polling address or tag may not match the device.	Check the Polling Options to ensure the proper polling type is selected.
Control system is communicating HART, but the Field Communicator is not communicating properly.	HART communication is being prevented by the control system.	Stop HART communications on the control system and verify if communication between the devices and the 475 is restored.
	More than one Field Communicator or other Secondary Master may be attached to the control loop.	Ensure there is only one Primary Master and one Secondary Master on the control loop.
A HART device appears at multiple addresses.	The incorrect polling addresses may be used.	Change the addresses being polled. See “Changing the HART Polling Options” on page 3-15.
	HART revision 5 (or earlier), 6, and 7 devices are on the same loop	Put HART 5 or earlier devices on a separate loop from HART 6 or 7 devices.

Table 5-2. Troubleshooting Table for the Fieldbus Protocol

Symptom	Possible Causes	Solution
No communication with device.	The Field Communicator is connected to a segment with DeltaV and the device on the same segment is being commissioned using DeltaV.	The Field Communicator is unable to communicate with this device until you go offline and then back online.
Connected to a segment in a bench configuration and the Live Device List remains blank (even the Field Communicator does not appear).	This issue is caused by the speed at which certain LAS-enabled devices are attempting to run the segment.	Establish communication by putting the Field Communicator on the segment first and then adding one or more devices. By putting the Field Communicator on first, it will remain the LAS and control the communication.
Unable to change the address of a device.	The Field Communicator is unable to change the address of a device that is currently the LAS.	Establish communication by putting the Field Communicator on the segment first and then adding one or more devices. By putting the Field Communicator on first, it will remain the LAS and allow the address change.
The Field Communicator does not remain the LAS on a segment.	A host takes over as the LAS. A backup LAS takes over as the LAS. The lower the address and Slot Time of the device, the more likely this will occur.	When a host is established on a segment, it will take over as the LAS. No action is required. See "Changing the Slot Time" on page 4-16.



## ERROR AND STATUS MESSAGES

General Error Messages	Description
<p>License file check failed - error code x. Please contact service center to resolve this problem. Press <b>OK</b> to turn off. (Where x indicates the test that failed.)</p>	<p>License file check failed during power- up.</p>
<p>Warning: System incompatibility detected - error code x. Start Listen For PC and use the Easy Upgrade Utility to resolve this, turn off your Field Communicator and contact service center to resolve this. (Where x is an error code indicating what the incompatibility detected was or related errors.)</p>	<p>Hardware version or operating system in your Field Communicator is not compatible.</p>
<p>Installation file is corrupt - error code x. Please call service center to resolve this problem. Press OK to turn off.</p>	<p>The installation is corrupt.</p>
<p>This Field Communicator is not licensed for FOUNDATION Fieldbus.</p>	<p>Your 475 Field Communicator is not licensed for FOUNDATION fieldbus functionality. Contact your sales representative for information about adding this functionality.</p>
<p>The Field Communicator is not licensed for Bluetooth communication.</p>	<p>Your 475 Field Communicator is not licensed and does not have the necessary hardware for Bluetooth communication. Contact your sales representative for information about this functionality.</p>
<p>The Field Communicator does not detect a System Card. Please make sure your System Card is properly installed in its slot. Press OK to turn off.</p>	<p>The System Card is improperly installed in the System Card socket or the System Card is missing. The System Card socket is spring-loaded. Ensure that when you insert the System Card into the socket, you hear a click.</p> <p>Also ensure the System Card has the metal card contacts facing up when you insert the card. See "Installing the System Card and the Battery" on page 2-10. The System Card may be damaged if inserted improperly.</p>

HART Error Messages	Description
Hart Application Error... "registry failure"...Reinstall System Files...See User's Manual for details.	A registry setting in the 475 is corrupted. From the Field Communicator Main Menu, do the following: 1. Double tap <b>Settings</b> . 2. Double-tap <b>About Field Communicator</b> . 3. Double-tap <b>RE-FLASH</b> . 4. Tap <b>Yes</b> to proceed.
Voltage detected on FF connectors. Check your connectors and press OK.	Insert the lead set connectors into the HART communication terminals on the top of the 475. The access door shows which protocols terminals are exposed.
CDC Error..."failure while switching to HART"...Reinstall System Files...See User's Manual for details.	The HART Application fails to put the CDC in HART mode for talking to a HART device. From the Field Communicator Main Menu, do the following: 1. Double tap <b>Settings</b> . 2. Double-tap <b>About Field Communicator</b> . 3. Double-tap <b>RE-FLASH</b> . 4. Tap <b>Yes</b> to proceed.
DD Error..."tokenizer mismatch"...DD version <manufacturer name, device name, dev. rev. #, and DD rev. #>; HART application <version x.y>; HART app version x.y...Reinstall DD...See Programming Interface for details.	The version of the tokenizer used to tokenize the device description is not what the HART Application expects and the device description is incompatible with the installed HART Application version. Upgrade the system software and device descriptions in the Field Communicator using the Field Communicator Easy Upgrade Utility.
DD Error..."linker mismatch"...DD version x.y; HART app version x.y...Reinstall DD...See Programming Interface for details.	The version of the linker used to link the device description is not what the HART Application expects and the device description is incompatible with the installed HART Application version. Upgrade the system software and device descriptions using the Field Communicator Easy Upgrade Utility.
DD Error..."developed-to mismatch"...DD version <manufacturer name, device name, dev. rev. #, and DD rev. #>; HART application <version x.y>...See Programming Interface for solution.	The device description was developed and tested for a later HART Application revision. Upgrade the system software and device descriptions using the Field Communicator Easy Upgrade Utility.
Warning: this DD is untested with the current Hart App ver <manufacturer name, device name, dev. rev. #, and DD rev. #>...you may experience unexpected or inappropriate results...See Programming Interface for details on DD updates...Do you want to accept these risks and proceed?	The device description was not tested and verified with the installed version of the HART Application. Obtain a newer version of the device description using the Field Communicator Easy Upgrade Utility.
DD Error..."tested-to sequence mismatch"...DD version <manufacturer name, device name, dev. rev. #, and DD rev. #>; HART application <version x.y>; HART app version x.y...See Programming Utility for solution.	The DD was tested with a previous version, but not with this version of the HART Application. Obtain a newer version of the device description using the Field Communicator Easy Upgrade Utility.
DD Error..."developed-to mismatch"...DD version <manufacturer name, device name, dev. rev. #, and DD rev. #>; HART application <version x.y>; HART app version x.y...See Programming Utility for details	The DD was developed using a later HART Application revision. Upgrade the system software and device descriptions using the Field Communicator Easy Upgrade Utility.

<p>Device Description Error...'Device Description header file corrupted'...To repair, reinstall the Device Descriptions for %s %s dev rev %d DD rev %d...see Programming Utility for details...Press FWDCOM to attempt to load an earlier Device Description."</p>	<p>There is a check sum error in the device description header file. Obtain a newer version of the device description using the Field Communicator Easy Upgrade Utility.</p>
<p>Communication Error...See User's Manual for solution.</p>	<p>Check the wiring to the device.</p>
<p>Forward Compatibility Blocked...The Device Description for x Device Rev x dd Rev x cannot be used in forward compatibility mode...x... Press OK to load the Generic Device Description.</p>	<p>The HART Application attempts to use a device description to run in forward compatibility mode and finds that it cannot. A generic device description will be used.</p>
<p>Device Description Not Installed...The Device Description for device type x device rev x is not installed on the System Card...See Programming Interface for details on Device Description updates...Do you wish to proceed in forward compatibility mode?</p>	<p>The device description for the connected device is not in the 475 Field Communicator. If you have the Easy Upgrade option, you can add device descriptions to your 475 Field Communicator from the Field Communicator Easy Upgrade Utility.</p>
<p>Do you want to ignore this message while communicating with this device?</p>	<p>The HART Application lets you ignore some response code warning messages, such as Update Failure, while communicating with a device. The next time you communicate with the device, this message will appear.</p>

Fieldbus Error Messages	Description
Connection Error - Voltage Detected on HART connectors. Please check your connectors. Press OK to retry connecting to the segment. Press CANCEL to end the Fieldbus Application.	Insert the lead set connectors into the fieldbus communication terminals on the top of the 475. The access door shows which protocols terminals are exposed.
Connection error - Polarity reversed on the fieldbus segment connection. Please reverse connectors. Press OK to recheck polarity.	The lead set connectors attached to the 475 Field Communicator need to be reversed (rotated) and reconnected to the 475. The fieldbus terminals are polarity sensitive.
DDP Error 1: Unable to load DD. Press OK to return to Block List.	Using the Field Communicator Easy Upgrade Utility, check to see if this device description is available to load into your 475 Field Communicator. If not, contact the device manufacturer.
There has been a loss of communication with one or more devices on the segment. Press OK to return to the Fieldbus Live Device List.	Check connection to fieldbus devices.
The Field Communicator has been disconnected from the segment. Press RETRY to attempt to reconnect to the segment. Press CANCEL to return to the Fieldbus Application main menu. Press EXIT to exit the Fieldbus Application.	Verify that the 475 Field Communicator lead set is still securely connected to the FF Segment and tap <b>RETRY</b> .
SM ERROR: FAILED RESPONDER IDENTIFY	There is a problem sustaining communications with the device. Contact 475 Field Communicator Technical Support personnel.
FFLIB: Incompatible DD Static Description	The device description (DD) does not match the actual device. Use the Field Communicator Easy Upgrade Utility to see if a new DD is available for that device. Contact 475 Field Communicator Technical Support personnel. See <a href="http://www.fieldcommunicator.com">http://www.fieldcommunicator.com</a> .
Device Upload aborted. Press OK to return to the Fieldbus Live Device List.	Communication with a device has timed out. This should normally not happen, unless a host was selected. Contact 475 Field Communicator Technical Support personnel.
Function Block Service Error: Parameter Check	The parameter value being entered is invalid for this device. Check with the device supplier. Make sure the value entered is valid for that specific device parameter.
Function Block Service Error: Exceeds Parameter Limits	The parameter value being entered is outside the range of valid values for the device parameter. Check with the device supplier. Make sure the value entered is in the correct range for that device parameter.
Function Block Service Error: Wrong Mode For Request	The block is in the wrong mode to accept the parameter change being requested. See "Change Modes" on page 4-10 for information on how to change block modes.
SM ERROR: REMOTE ERROR INVALID STATE	An attempt to change the address of the device serving as the LAS on the segment is being made. Changing the device address of the LAS is not recommended.

---

## INFORMATION FOR TECHNICAL SUPPORT

Before you call Technical Support personnel, have a detailed description of the issue, including the information below (if applicable). Have the User's Manual for the device available.

- 475 Field Communicator system software revision.
- What is the serial number of the 475 Field Communicator having the communication issue? This is located on the battery label on the back of the Field Communicator.
- Manufacturer and model of control system.
- Does the control system support HART or fieldbus communications?
- Device manufacturer name (or ID) and model revision of device (as displayed on the 475 Field Communicator, exact spelling if possible.)
- What task is being performed when the communication problem occurs?
- Can AMS Device Manager or another Field Communicator talk to the device?
- Are you having communication problems with multiple devices?
- Are there any error messages displayed when attempting to communicate with a device (e.g., device not found)?
- Does communication work when certain devices or processes are not running?
- What is the total cable length run from the termination panel to the device?
- What is the loop impedance in the HART device loop? (resistance value)
- If a HART multiplexer is being used, what is the manufacturer and model?
- Is the device in burst mode?
- Is the device address set to "0"?
- Is there more than one device on the loop?
- Is there another master (primary or secondary) on the loop? (i.e., control system, multiplexer, etc.)

### Contacting Technical Support Personnel

Contact your supplier or go to <http://www.fieldcommunicator.com> for Technical Support contact information.



## APPENDIX A

## REFERENCE DATA

### PROCESSOR AND MEMORY SPECIFICATIONS

<b>Microprocessor</b>	80 MHz, max 133 MHz Hitachi® SH3
<b>Memory</b>	<b>Internal Flash</b> 32 MB
	<b>System Card</b> 1 GB Secure Digital card or higher
	<b>RAM</b> 32 MB

### PHYSICAL SPECIFICATIONS

<b>Weight</b>	Approximately 1.65 lb (750 grams) includes battery
<b>Display</b>	3.5" diagonal, 1/4 VGA (240 by 320 pixels) color touch screen Hard-coated surface Dimensions approximately 2.79" x 2.10" (71 mm x 53.3 mm)
<b>Keypad</b>	The keypad consists of the following: <ul style="list-style-type: none"><li>• A Power key to turn on and off the 475 or to put it in standby</li><li>• A Backlight key to adjust the intensity of the light on the screen</li><li>• Four navigation (arrow) keys to select, open, and back out of menu items</li><li>• An Enter key to open menu items from the Field Communicator Main Menu or Settings menu, and select any highlighted button</li><li>• A Tab key to move between buttons or fields on a window</li><li>• A Function key that enables alternate functionality indicated by the blue text near the keys</li><li>• Alphanumeric keys for entering data</li></ul>

### USAGE SPECIFICATIONS

<b>Temperature Limits</b>	+14°F to +122°F (-10°C to +50°C) 0% to 95%RH (non-condensing) for +32°F to +122°F (0°C to +50°C)
<b>Storage with Batteries</b>	-4°F to 131°F (-20°C to +55°C) for less than 1 month
<b>Storage Without Batteries</b>	-4°F to +140°F (-20°C to +60°C)
<b>Enclosure Rating</b>	IP51 (front)

---

**Shock**

Passes the 1-meter drop test onto concrete

**General Guidelines**

- Only use new, original parts.
- Do not recharge the battery in hazardous areas.
- Have repairs done by only qualified personnel.
- Charge or power using only the Field Communicator power supply/charger.

**CONNECTION SPECIFICATIONS****HART and Fieldbus Communication Terminals**

Three 4mm banana plugs (one common terminal to both HART and FOUNDATION fieldbus.)

**Connection Types****IrDA Port**

± 15 degrees recommended maximum angle between the 475 interface and adapter or PC.

18 in. recommended maximum distance between the 475 interface and adapter or PC.

**Bluetooth Interface**

The Bluetooth Interface is a licensed option for the 475 Field Communicator. If your 475 is not licensed for Bluetooth, it does not have a Bluetooth radio. To use Bluetooth you need an approved adapter using the Windows Bluetooth software and drivers included with Windows XP Professional Service Pack 2 or 3 or Windows Vista Business Service Pack 1. The adapter should be plug-and-play if no other Bluetooth software or drivers were installed on your PC. The Easy Upgrade Utility cannot communicate with an adapter using third-party drivers. See [www.fieldcommunicator.com](http://www.fieldcommunicator.com) or the readme file for more information.

30 feet (10 meters) recommended maximum distance between the 475 and a Bluetooth adapter attached to a PC.

**Card Reader**

Only supported card readers can be used with the System Card. Unsupported card readers may corrupt files. See the readme file on your Resource CD or [www.fieldcommunicator.com](http://www.fieldcommunicator.com) for the list of supported card readers.

The card reader can be used only with the Field Communicator Easy Upgrade Utility.

**BATTERY SPECIFICATIONS****Battery Type**

Two rechargeable Li-Ion cells, not serviceable

**Connection**

Green six-pin mini din (female) jack on the side of the battery

**Charge**

+50°F to +104°F (10°C to +40°C)

**Guidelines for the Li-Ion Battery (Power Module)**

- Do not recharge the battery in hazardous areas. The power supply/charger is not IS-approved.
- Charge or power using only the Field Communicator power supply/charger.
- Recharge the battery frequently, preferably after each use. Limit full discharges, if possible.



**Lights**

Five lights (LEDs) on the side of the battery indicate the remaining level of battery charge. When you press and release the Charge Indicator button below these lights, the lights slowly illuminate. Each light indicates 20 percent of remaining charge, and the battery is fully charged when all of the lights are illuminated. See Figure 2-1 on page 2-3 for the location of the Charge Indicator button.

**Operating Time**

10 or more hours when the backlight is to highest setting  
 20 or more hours when the backlight is off  
 80 or more hours when using standby

**Storage**

-4°F to +131°F (-20°C to +55°C) less than one month

**Storage Guidelines for the Li-Ion Battery**

- Use a location at room temperature or cooler. Prolonged storage at higher temperatures can permanently reduce the charge capacity and performance.
- Ensure the remaining charge is at or near mid-capacity. The charge will slowly drain during storage. Periodically recharge the battery during storage to ensure it does not drain to low levels.

## POWER SUPPLY/CHARGER SPECIFICATIONS

**Connection**

Green six-pin mini din (male) plug

**Lights**

The power supply/charger has three colored lights that indicate the conditions below. Each light displays a different color.

Color	Condition
Green	The battery is fully charged.
Flashing green	The battery is nearly fully charged.
Amber	The battery is charging.
Flashing amber	The power supply/charger is not connected to the 475 Field Communicator.
Flashing amber and red	The remaining charge in the battery is low.
Red	Charging cannot occur. Contact Technical Support for more information.

**Voltage**

100-240 VAC, 50/60Hz,  
 US/UK/EU connection types included

---

**Technical Data**

Input voltage	100 - 240 VAC $\pm$ 10%
Input current	750 mA max.
Standby current	20 mA max.
Input fuse type	TES 2A 250 V Timelag
Output voltage 1	0 - 8.3 V
Output current 1	1000 mA max.
Output voltage 2	0 - 9.0 V
Output current 2	1400 mA max.
Output power rating	20 W
Operating temperature	0°C - +40°C
Storage temperature	-20°C -+80°C
Measurements [L x B x H]	112 mm x 51.5 mm x 29.5 mm
Total Mass	240 g.

## ORDER INFORMATION

Model	Product Description
475	Field Communicator <b>(Note 1)</b>
Code	Communication Protocol
H	HART
F	HART and FOUNDATION fieldbus <b>(Note 2)</b>
Code	Battery Type
P	Rechargeable Li-ion Power Module
Code	Power Supply/Charger
1	Power Supply/Charger Li-ion/NiMH US/UK/EU connection types included <b>(Note 3)</b>
9	Not Included <b>(Note 4)</b>
Code	Language
E	English
D	German <i>(Available to ship Sept 09)</i>
J	Japanese <i>(Available to ship in early 2010)</i>
R	Russian <i>(Available to ship Sept 09)</i>
Code	Product Certifications
KL	ATEX, FM, CSA and IECEx Intrinsically Safe (includes FISCO as applicable)
NA	No Approval
Code	Easy Upgrade
U	Easy Upgrade Option (3 year) <b>(Note 5)</b>
9	Not Included
Code	Included Options
GM	Graphics (Included at no charge) <b>(Note 6)</b>
GM	Device Configuration Management (Included at no charge) <b>(Note 7)</b>
Bluetooth	
T	Bluetooth Communications <b>(Note 8)</b>
9	No Bluetooth Communication
Options	
Spare Battery	
A	Spare Rechargeable Li-ion Power Module <b>(Note 9)</b>
Enclosures	
S	Protective Rubber Boot with Stand (Boot available to ship Oct 09)
<b>Typical HART Model Number: 475 H P 1 E KL U GMT</b>	
<b>Typical HART/Fieldbus Model Number: 475 F P 1 E KL U GMT</b>	

- (1) Base Model 475 includes Field Communicator unit with color LCD display, System Card, Leadset with connectors, Carrying Case, Getting Started Guide, 475 Resource CD, stylus and straps.
- (2) This option requires that the Easy Upgrade option (code U) is specified.
- (3) To obtain an Australian Power Cord, order part number 00375-0003-0003.
- (4) This option should only be considered if the user already has a 375 or 475 Power Supply/Charger. If it is a 375 Power Supply/Charger, it must be the Li-Ion/NiMH version.
- (5) The Easy Upgrade feature allows the user to add new System Application software and device descriptions (DDs) to the 475 for a period of 3 years. To upgrade without this feature, the System Card would have to be sent to a Service Center.
- (6) The Graphics Option enables a user to access enhanced graphical features when using the HART or FOUNDATION fieldbus application.
- (7) Device Configuration Management provides the capability to store up to 1000 configurations and print them using the Easy Upgrade Utility.
- (8) Bluetooth enables communication to a PC via the Bluetooth protocol. See list of countries with Bluetooth approval at [www.fieldcommunicator.com](http://www.fieldcommunicator.com).
- (9) A fully charged Li-Ion Power Module is capable of delivering power for 20 hours of typical field use. If requirements exceed this specification, a spare Power Module (code A) should be specified.

## SPARE PARTS LIST

Description	Part Number
Ruggedized 250 Ohm Load Resistor	00275-0096-0001
Rechargeable Li-Ion Power Module	00475-0002-0022
Power Supply/Charger (Li-Ion/NiMH) US/UK/EU connection types included	00475-0003-0022
Power Supply/Charger Standard cord set (US/UK/EU cords)	00375-0003-0002
Australian (AU cord) for Power Supply/Charger	00375-0003-0003
Lead Set with connectors	00375-0004-0001
Hand Strap (pack of 2)	00475-0005-0002
Carrying Case (with spare Hand Strap and Stylus)	00475-0005-0003
Magnetic Hanger (Magnetic Hanger available to ship Sept 09)	00475-0005-0004
Protective Rubber Boot with stand (Boot available to ship Oct 09)	00475-0005-0005
Stylus (pack of 2)	00475-0006-0001
IrDA to USB Adapter ( <b>Note 1</b> )	00375-0015-0002
System Card (SD) Reader (with USB interface) ( <b>Note 2</b> )	00375-0018-0022
Bluetooth Adapter ( <b>Note 1</b> )	00475-0018-0023
Stand	00475-0044-0001
Getting Started Guide	00475-0045-3001
Resource CD	00475-0049-0001
<b>Online Licensing (Note 4)</b>	
FOUNDATION fieldbus license via Web	00375-0142-0002
Easy Upgrade (New) license via Web ( <b>Note 3</b> )	00375-0142-0003
Easy Upgrade (Renew) license via Web ( <b>Notes 3 and 5</b> )	00375-0142-2003
<b>AMS Device Manager Handheld Interface Kit (Note 6)</b>	
AMS Suite: Intelligent Device Manager Field Communicator Interface Kit (25 tags)	AW7005HC00025
AMS Suite: Intelligent Device Manager Field Communicator Interface Kit (100 tags and above)	AW7005HC20000

- (1) Can be used to support communication between the 375/475 and the Easy Upgrade Programming Utility or AMS Device Manager (with Handheld Communicator Interface Kit). Either IrDA or Bluetooth Communication is required to register the 375/475 or use the Online Licensing system.
- (2) The System Card (SD) Reader allows a user the ability to upgrade a System Card much faster than they can when using IrDA or Bluetooth. Due to the file size constraints, major upgrades require the use of a card reader.
- (3) The Easy Upgrade feature allows the user to add System Application Software and device descriptions (DDs) to the 475 for a period of 3 years. To upgrade without this feature, the System Card would have to be sent to a Service Center (fee would apply).
- (4) These parts support license upgrades of System Cards in the field through the use of the Field Communicator Online Licensing system. The capability is available to end users and may also be performed by an agent on the user's behalf. It is at the agent's discretion if an additional fee should apply. Any order must be accompanied by the System Card S/N. Instant notification of when the licenses are available for download are sent to emails provided at time of order. For further details, see the Online Licensing procedure at [www.fieldcommunicator.com](http://www.fieldcommunicator.com).
- (5) The ReNew option is available on System Cards where the Easy Upgrade license has been expired for less than 90 days. Date of expiration can be obtained by interfacing the 475 with v3.0 (or higher) of the Easy Upgrade Programming Utility.
- (6) Requires AMS Device Manager (version 6.2 or higher). Both AMS Device Manager and the Handheld Communicator Interface kit are available for sale through select channels only. See [www.assetweb.com](http://www.assetweb.com) for further details.

## APPENDIX B

## PRODUCT CERTIFICATIONS

### OVERVIEW

All 475 Field Communicators come with the main unit label (see Figure B-1). Intrinsically Safe (KL option) 475 Field Communicators also have an additional label opposite the main unit label on the back of the Field Communicator. If the 475 Field Communicator does not contain this label (NA option), then it is considered non-IS approved. The Declaration of Conformity and other approval information are available on [www.fieldcommunicator.com](http://www.fieldcommunicator.com).

The Federal Communications Commission (FCC), Industry Canada (IC), and Radio and Telecommunications Terminal Equipment (R&TTE) approvals apply to only 475 Field Communicators licensed for Bluetooth.

### APPROVED MANUFACTURING LOCATIONS

Emerson Process Management — Leicester, England

### FCC

This equipment has been tested and found to comply with the limits for a Class A digital device, pursuant to part 15 of the FCC Rules. These limits are designed to provide reasonable protection against harmful interference when the equipment is operated in a commercial environment. This equipment generates, uses, and can radiate radio frequency energy and, if not installed and used in accordance with the user's manual, may cause harmful interference to radio communications. Operation of this equipment in a residential area is likely to cause harmful interference in which case the user will be required to correct the interference at his own expense.

This device complies with Part 15 of the FCC Rules. Operation is subject to the following two conditions: (1) this device may not cause harmful interference, and (2) this device must accept any interference received, including interference that may cause undesired operation.

Any modifications made to this device that are not approved by Emerson Process Management may void the authority granted to the user by the FCC to operate this equipment.

### IC

This Class A digital apparatus complies with Canadian ICES-003.

Cet appareil numérique de la classe A est conforme à la norme NMB-003 du Canada.

---

## EUROPEAN DIRECTIVE INFORMATION - CE COMPLIANCE

### R&TTE

This equipment is in conformity with the Radio and Telecommunications Terminal Equipment (R&TTE) Directive 1999/5/EC.

### Electro Magnetic Compatibility (2004/108/EC)

Tested to the EN 61326-1 specification.

### ATEX Directive (94/9/EC) (KL option only)

See the "European Certifications" on page B-2 for more information.

## HAZARDOUS LOCATIONS CERTIFICATIONS (KL OPTION ONLY)

The Intrinsic Safety approvals listed in this section include compliance with the FISCO requirements.

### European Certifications

#### ATEX Intrinsic Safety

Emerson Process Management complies with the ATEX Directive (94/9/EC).

Specific ATEX Directive Information is located within this section and in the 475 Field Communicator Getting Started Guide.

Applicable standards EN 60079-0, EN 60079-11, EN 60079-26, and EN 60079-27.

Certification No.: BVS 09 ATEX E 023

⊕ II 2 G (1 GD) Ex ia IIC T4 (-10°C ≤ Ta ≤ +50°C)

CE 1180

#### HART Intrinsically Safe Electrical Parameters

##### Input Parameters

$U_i$  = 30 Volt DC

$I_i$  = 200 mA

$P_i$  = 1.0 Watt

$L_i$  = 0

$C_i$  = 0

##### Output Parameters

$U_o$  = 1.9 Volt DC

$I_o$  = 32 μA

#### FOUNDATION fieldbus

The FISCO standard applies to the FM, CSA, IECEx, and ATEX certifications.

##### Intrinsically Safe FISCO

$U_{iIIC}$  = 17.5 Volt DC     $I_{iIIC}$  = 215 mA     $P_{iIIC}$  = 1.9 Watt

$U_{iIIB}$  = 17.5 Volt DC     $I_{iIIB}$  = 380 mA     $P_{iIIB}$  = 5.3 Watt

$U_o$  = 1.9 Volt DC     $I_o$  = 32 μA

##### Intrinsically Safe Non-FISCO

$U_i$  = 30 Volt DC     $I_i$  = 380 mA     $P_i$  = 1.3 Watt

$U_o$  = 1.9 Volt DC     $I_o$  = 32 μA

$L_i$  = 0     $C_i$  = 0

**International Certification**

**IECEX**

Certification No.: IECEX BVS 09.0012  
 Ex ia IIC T4 (-10°C ≤ Ta ≤ +50°C)

**North American Certifications**

**Factory Mutual (FM)**

Intrinsically Safe for Class I, Division 1, Groups A, B, C, and D and Class I, Zone 0, AEx ia IIC T4 (Ta = 50°C) hazardous locations when connected as indicated in the control drawing 00475-1130. See the control drawing for input and output parameters.

**Canadian Standards Association (CSA)**

Intrinsically Safe for use in Class I, Zone 0, Ex ia IIC T4 (Ta = 50°C) hazardous locations when connected as indicated in the control drawing 00475-1130. See the control drawing for input and output parameters. Please note the parameters in the control drawing are the same as the FM parameters.

**POWER SUPPLY/CHARGER CERTIFICATION**

**Declaration of Conformity/Approvals**

The 475 Field Communicator power supply/charger complies to the requirements of the relevant EU directives. The conformity assessment process has been successfully completed as per the directives listed below. All approval information for this product can be accessed at [www.fieldcommunicator.com](http://www.fieldcommunicator.com).

**European Union Directives**

Low Voltage Directive 2006/95/EC  
 EN 60950: 2001 + A11  
 EMC Directive 2004/108/EC

The following harmonized standards were applied, immunity EN61204-3:2000  
 RoHS (2002/95/EC) directive  
 WEEE (2002/96/EC) directive

**Japanese Directives**

DENAN/PSE

**LABEL DRAWINGS**

Figure B-1. All 475 Field Communicators have a similar label to the one below.

**Label 1-1**  
**ZN:2009 08 50 0**

**44.0mm**

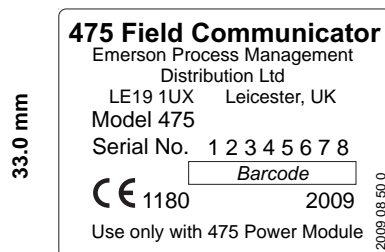

**R = 1.5 mm**

Figure B-2. Approval Ex Label Example (Only on 475 Field Communicators with the KL option)

**Label 1-2**  
**ZN:2009 08 51 0**

44.0mm

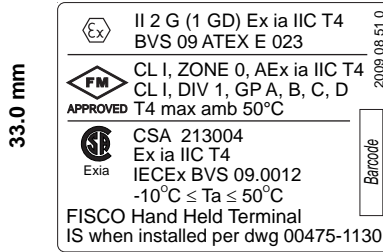

R = 1.5 mm

Figure B-3. Bluetooth Approval Label Example

**Label 1-4**  
**ZN: 2009 08 53 0**

44.0mm

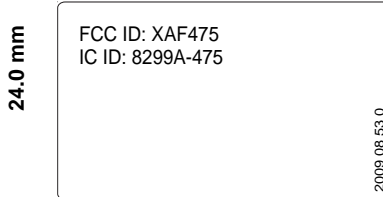

R = 1.5 mm

Figure B-4. Battery Label Examples

**Label 4-1**  
**ZN:2009 08 54 0**

49.0mm

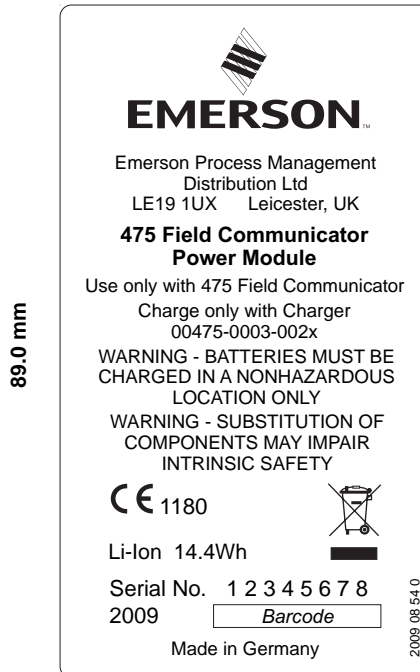

R = 1.5 mm



**Label 4-2**  
**ZN:2009 08 55 0**

**37.0mm**

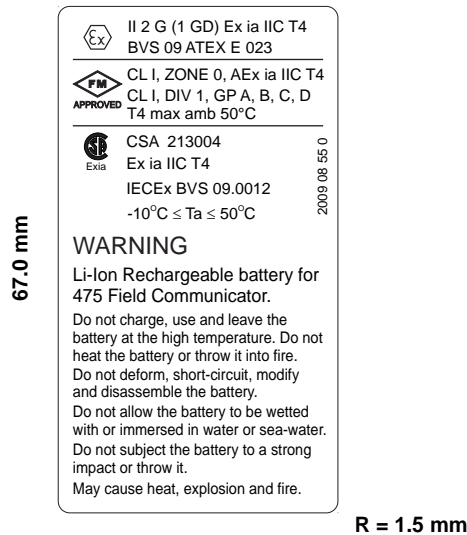

Figure B-5. Waste Electrical and Electronic Equipment (WEEE) label

Products with the following label comply with the Waste Electrical and Electronic Equipment (WEEE) directive, 2002/96/EC, which applies to European Union (EU) member states only.



The label indicates this product should be recycled and not treated as household waste. Customers in EU member states should contact their local Emerson sales representative for information on discarding any part of the 475 Field Communicator.

For customers in all other world areas, if it is necessary to discard any part of the 475 Field Communicator, follow the waste-disposal regulations applicable in your location.

Figure B-6. RoHS label

Products with the following label are lead-free and comply with the Restriction of the Use of Certain Hazardous Substances in Electrical and Electronic Equipment (RoHS) directive, 2002/95/EC, which applies to EU member states only.



The purpose of the directive is to limit the use of lead, cadmium, mercury, hexavalent chromium, polybrominated biphenyl (PBB), and polybrominated diphenyl ether (PBDE) flame retardants in electronic equipment.

APPROVAL DRAWINGS

This approval drawing can also be found on the www.fieldcommunicator.com website.

THIS DRAWING IS PROPERTY OF AND PROPRIETARY TO EMERSON PROCESS MANAGEMENT. THIS DRAWING AND THE INFORMATION CONTAINED HEREIN SHALL NOT BE REPRODUCED, COPIED, DISCLOSED TO ANYONE EXCEPT THOSE REMAINING IN THE EMPLOY OF EMERSON PROCESS MANAGEMENT, OR BE LOANED, REPRODUCED, COPIED, DISCLOSED TO ANYONE OR RETURNED TO EMERSON WHEN NO LONGER REQUIRED FOR THOSE PURPOSES.

**TABLE 1 - FM ENTRY PARAMETERS**

Input Parameter	Output Parameter
ULI (Open) = 30 VDC	U (Open) = 1.4 VDC
ULI (Close) = 30 VDC	U (Close) = 1.4 VDC
I (Open) = 300 mA	I (Open) = 300 mA
I (Close) = 300 mA	I (Close) = 300 mA
CSA = Ex Ia IIC	CSA = Ex Ia IIC

Parameter	Value
ULI (Open)	1.4 VDC
ULI (Close)	1.4 VDC
I (Open)	300 mA
I (Close)	300 mA
CSA	Ex Ia IIC

Classification: T4  
Max Ambient Temp: equal to T4  
Max Ambient Temp: less than or equal to 50°C

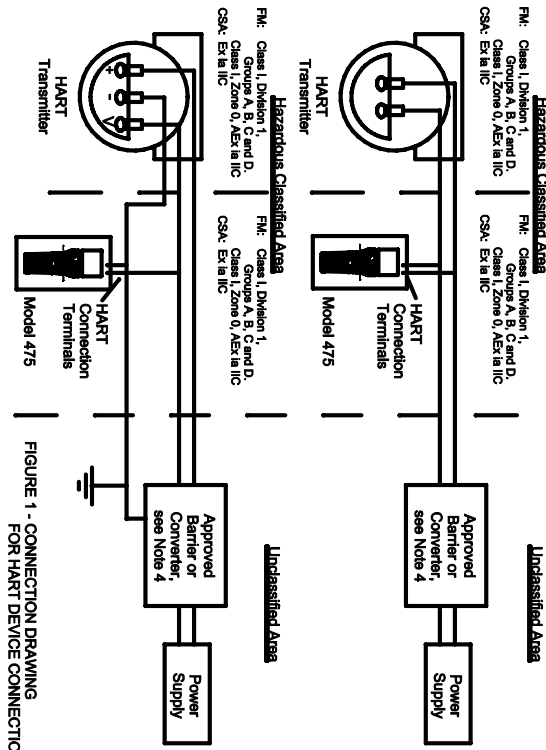

FIGURE 1 - CONNECTION DRAWING FOR HART DEVICE CONNECTION

**WARNING - BATTERIES MUST BE CHARGED IN A NON-HAZARDOUS LOCATIONS ONLY**  
**WARNING - SUBSTITUTION OF COMPONENTS MAY IMPAIR INTRINSIC SAFETY**

- Notes:**
- No revision to this drawing without prior FM Approval and CSA Transponder Approval.
  - Approved Apparatus must be installed in accordance with the applicable code for the installation.
  - Approved Apparatus and Model 475 Communicator must be installed in accordance with the applicable code.
  - UL, Vcc or Vt of the barrier plus Vcc of the Model 475 Communicator must be less than or equal to 11 (ten) VDC.
  - UL, Vcc or Vt of the barrier plus Vcc of the Model 475 Communicator must be less than or equal to 11 (ten) VDC.
  - CSA of barrier must be greater than or equal to IIC of the Model 475 Communicator plus C1 of the HART Transmitter.
  - UL of barrier must be greater than or equal to UL of the Model 475 Communicator plus UL of the HART Transmitter.
  - UL of Model 475 Communicator must be greater than or equal to UL of the HART Transmitter.
  - CSA of Model 475 Communicator must be greater than or equal to CSA of the HART Transmitter plus C1 of the Cable.
- FM:**
- The Associated Apparatus must be FM Approved.
  - HART Transmitter must be FM Approved when with the Model 475 Communicator.
  - Approved Apparatus must be FM Approved when with the Model 475 Communicator.
  - ANSI/ISA IEC 2/5/01 Transponder must be used in applications for Hazardous (Classified) Locations and must not use or generate more than 250V.
  - Approved Apparatus must be FM Approved.
  - Approved Apparatus must be FM Approved.
  - Approved Apparatus must be FM Approved.
  - Approved Apparatus must be FM Approved.
  - Approved Apparatus must be FM Approved.
  - Approved Apparatus must be FM Approved.
- CSA:**
- The Associated Apparatus must be CSA certified.
  - Model 475 Communicator must be CSA certified for use with the Model 475 Communicator.
  - Approved Apparatus must be CSA certified for use with the Model 475 Communicator.
  - Approved Apparatus must be CSA certified for use with the Model 475 Communicator.
  - Approved Apparatus must be CSA certified for use with the Model 475 Communicator.
  - Approved Apparatus must be CSA certified for use with the Model 475 Communicator.
  - Approved Apparatus must be CSA certified for use with the Model 475 Communicator.
  - Approved Apparatus must be CSA certified for use with the Model 475 Communicator.
  - Approved Apparatus must be CSA certified for use with the Model 475 Communicator.
  - Approved Apparatus must be CSA certified for use with the Model 475 Communicator.

UNLESS OTHERWISE SPECIFIED DIMENSIONS ARE IN INCHES		TOLERANCES	
DECIMALS:	X ± .030	XX ± .020	XXX ± .010
FRACTIONS:	± 1/32		
ANGULAR:	± 0° 30'		
FINISH:	32		
APPROVED AS SUBSTITUTION ITEM:			
DO NOT SCALE THIS DRAWING			

APPROVALS		EMERSON	
DESIGNED BY:	DATE:	DESIGNED BY:	DATE:
Wagner Hendh	1 April 08	Wagner Hendh	1 April 08
CHECKED BY:	DATE:	CHECKED BY:	DATE:
Wagner Hendh	1 April 08	Wagner Hendh	1 April 08
APPROVED BY:	DATE:	APPROVED BY:	DATE:
Wagner Hendh	1 April 08	Wagner Hendh	1 April 08

**Model 475  
IS Installation Drawing**

Emerson Process Management  
USA

00475-1130

REV	ECO NO.	DATE
P0	N/A	4-01-08

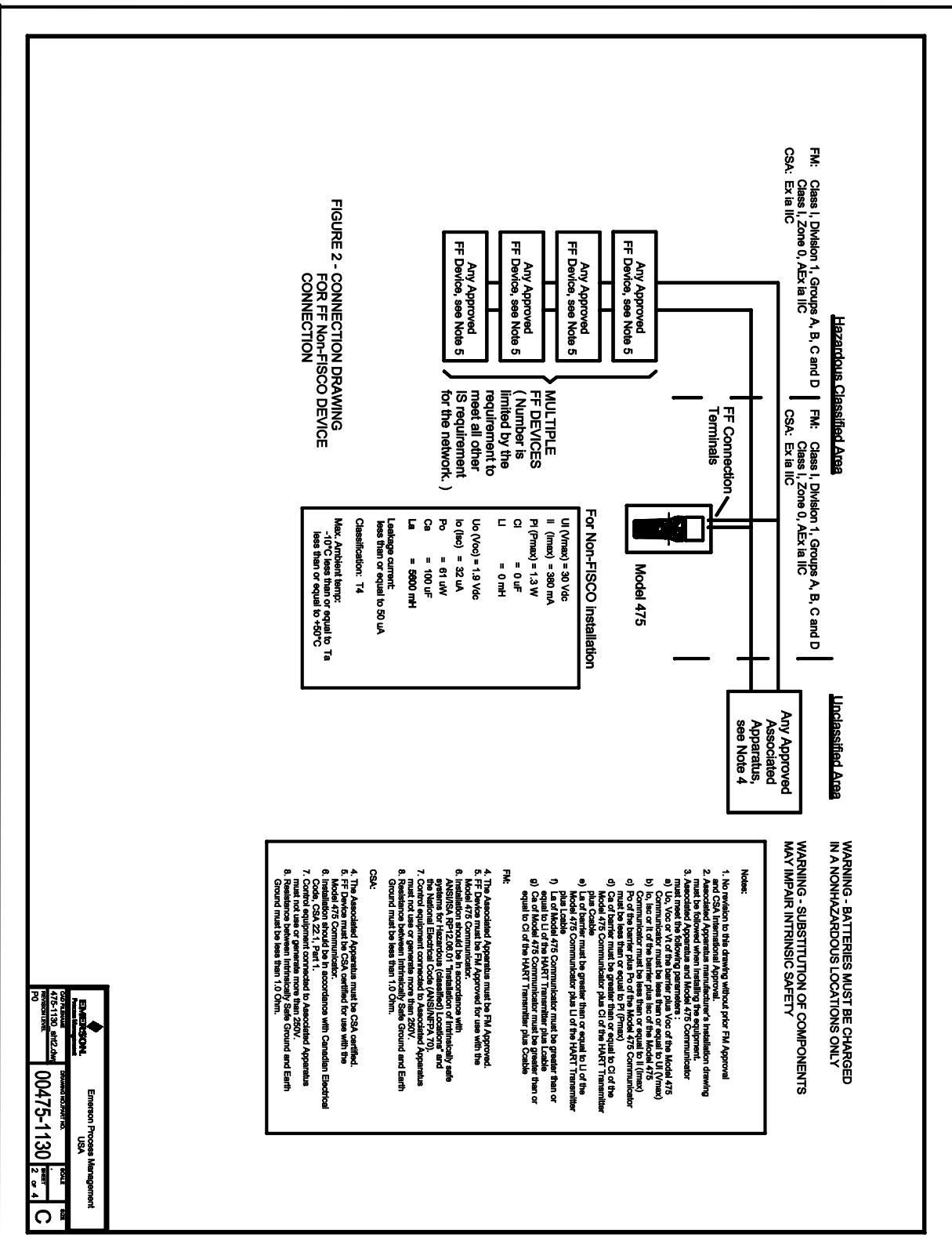

FIGURE 2 - CONNECTION DRAWING FOR FF Non-FISCO DEVICE CONNECTION

**WARNING - BATTERIES MUST BE CHARGED IN A NONHAZARDOUS LOCATIONS ONLY.**  
**WARNING - SUBSTITUTION OF COMPONENTS MAY IMPAIR INTRINSIC SAFETY**

- Notes:**
1. No revision to this drawing without prior FM Approval and CSA Transmittal Approval.
  2. Associated Apparatus and Model 475 Transmitter's installation drawing must be followed when installing the equipment.
  3. Associated Apparatus and Model 475 Communicator must meet the following parameters:
    - a) Intrinsic Safety: IIS (see Note 1) of the Model 475
    - b) Io, Ia or II of the barrier plus Ioc of the Model 475
    - c) Communicator must be less than or equal to PI (Pmax)
    - d) Communicator must be less than or equal to UI (Vrms)
    - e) Separation distance between Model 475 Communicator and Model 475 Transmitter must be greater than or equal to CI of the Model 475 Communicator plus CI of the Model 475 Transmitter
    - f) Ca of barrier must be greater than or equal to Ca of the Model 475 Communicator plus Ca of the Model 475 Transmitter
    - g) La of barrier must be greater than or equal to La of the Model 475 Communicator plus La of the Model 475 Transmitter
    - h) Le of barrier must be greater than or equal to Le of the Model 475 Communicator plus Le of the Model 475 Transmitter
    - i) Le of barrier must be greater than or equal to Le of the Model 475 Communicator plus Le of the Model 475 Transmitter
    - j) Ca of Model 475 Communicator must be greater than or equal to Ca of the Model 475 Transmitter plus Cable
    - k) La of Model 475 Communicator must be greater than or equal to La of the Model 475 Transmitter plus Cable
- FM:**
4. The Associated Apparatus must be FM Approved.
  5. FF Devices must be FM Approved for use with the Model 475 Communicator.
  6. Installation should be in accordance with ANS/ISA IEC 1206.01 Installation of Inherently safe systems for Hazardous (Classified) Locations and associated equipment (see Note 1).
  7. Control equipment connected to Associated Apparatus must not use or generate more than 250V.
  8. Resistance between Intrinsic Safety Ground and Earth Ground must be less than 1.0 Ohm.
- CSA:**
4. The Associated Apparatus must be CSA certified.
  5. FF Devices must be CSA certified for use with the Model 475 Communicator.
  6. Installation should be in accordance with Canadian Electrical Code, CSA C22.1 Part I, and to Associated Apparatus must not use or generate more than 250V.
  8. Resistance between Intrinsic Safety Ground and Earth Ground must be less than 1.0 Ohm.

		Emerson Process Management USA	
00475-1130 00475-1130 00475-1130 00475-1130	00475-1130 00475-1130 00475-1130 00475-1130	00475-1130 00475-1130 00475-1130 00475-1130	00475-1130 00475-1130 00475-1130 00475-1130
00475-1130 00475-1130 00475-1130 00475-1130	00475-1130 00475-1130 00475-1130 00475-1130	00475-1130 00475-1130 00475-1130 00475-1130	00475-1130 00475-1130 00475-1130 00475-1130

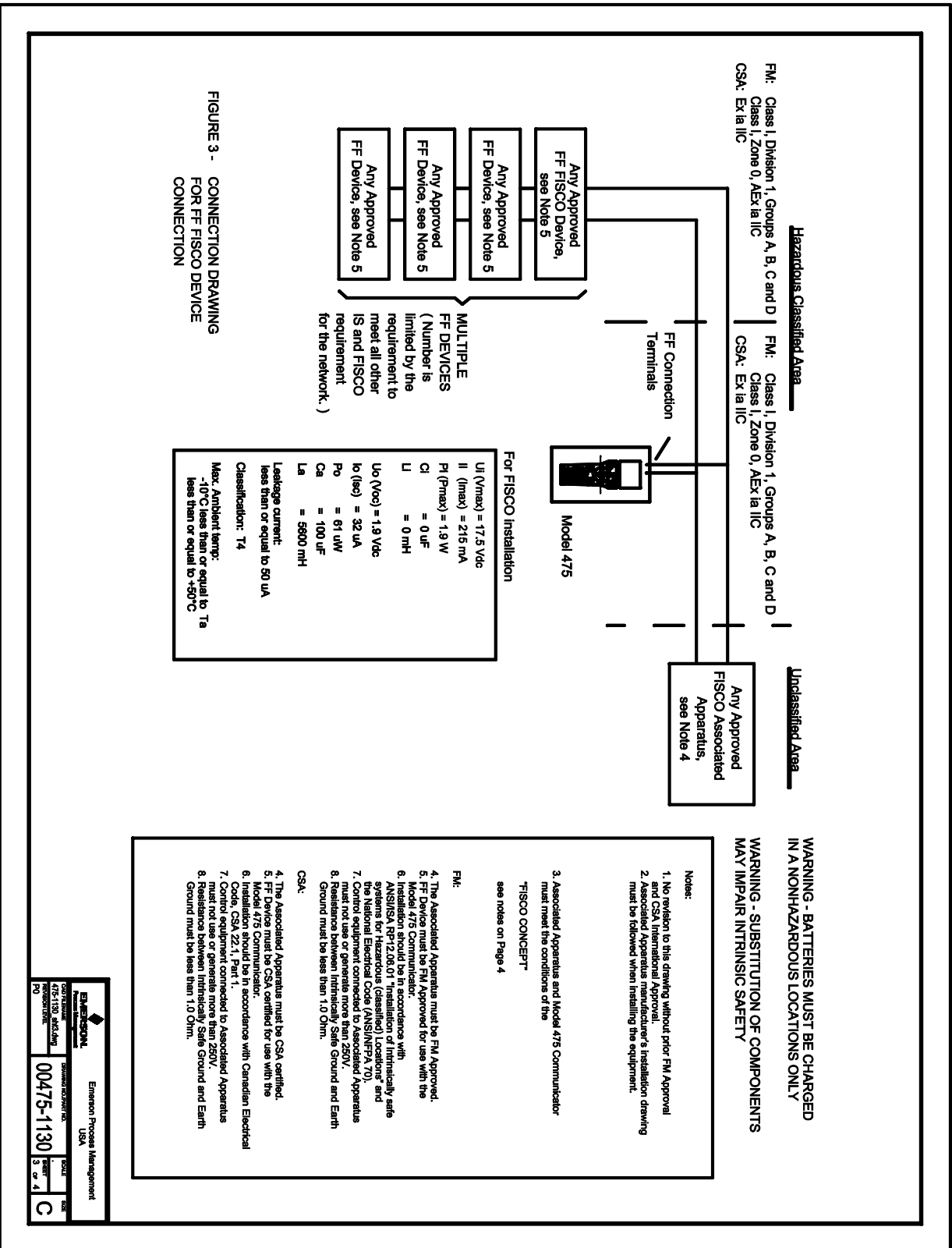

FIGURE 3 - CONNECTION DRAWING FOR FF FISCO DEVICE CONNECTION

**WARNING - BATTERIES MUST BE CHARGED IN A NONHAZARDOUS LOCATIONS ONLY**

**WARNING - SUBSTITUTION OF COMPONENTS MAY IMPAIR INTRINSIC SAFETY**

**EMERSON**  
Emission Process Management  
USA

Control Number: 475-130\_00475-130  
Revision: 3 of 1

DATE: 1/15/03

ISSUE: C

## **FISCO CONCEPT**

THE FISCO CONCEPT ALLOWS INTERCONNECTION OF INTRINSICALLY SAFE APPARATUS TO ASSOCIATED APPARATUS NOT SPECIALLY EXAMINED IN SUCH COMBINATION. THE CRITERIA FOR INTERCONNECTION IS THAT THE VOLTAGE (U<sub>I</sub> OR V<sub>max</sub>), THE CURRENT (I<sub>I</sub> OR I<sub>max</sub>) AND THE POWER (P<sub>I</sub> OR P<sub>max</sub>) WHICH AN INTRINSICALLY SAFE APPARATUS CAN RECEIVE AND REMAIN INTRINSICALLY SAFE CONSIDERING FAULTS, MUST BE EQUAL OR GREATER THAN VOLTAGE (U<sub>0</sub>, V<sub>oc</sub> OR V<sub>I</sub>), THE CURRENT (I<sub>0</sub>, I<sub>sc</sub> OR I<sub>I</sub>) AND THE POWER (P<sub>0</sub> OR P<sub>max</sub>) LEVELS WHICH CAN BE DELIVERED BY THE ASSOCIATED APPARATUS, CONSIDERING FAULTS AND APPLICABLE FACTORS. IN ADDITION, THE MAXIMUM UNPROTECTED CAPACITANCE (C<sub>I</sub>) AND THE INDUCTANCE (L<sub>I</sub>) OF EACH APPARATUS (OTHER THAN THE TERMINATION) CONNECTED TO THE FIELDBUS MUST BE LESS THAN OR EQUAL TO 5 nF and 10 uH RESPECTIVELY.

IN EACH SEGMENT ONLY ONE ACTIVE DEVICE, NORMALLY THE ASSOCIATED APPARATUS, IS ALLOWED TO PROVIDE THE NECESSARY ENERGY FOR THE FIELDBUS SYSTEM. THE VOLTAGE U<sub>0</sub> (OR V<sub>oc</sub> OR V<sub>I</sub>) OF THE ASSOCIATED APPARATUS IS LIMITED TO A RANGE OF 14 V TO 24 Vdc. ALL OTHER EQUIPMENT CONNECTED TO THE BUS CABLE HAS TO BE PASSIVE, MEANING THAT THEY ARE NOT ALLOWED TO PROVIDE ENERGY TO THE SYSTEM, EXCEPT A LEAKAGE CURRENT OF 50uA FOR EACH CONNECTED DEVICE. SEPARATELY POWERED EQUIPMENT NEEDS GALVANIC ISOLATION TO ASSURE THAT THE INTRINSICALLY SAFE FIELDBUS CIRCUIT REMAINS PASSIVE.

THE CABLE USED TO INTERCONNECT DEVICES NEEDS TO HAVE THE PARAMETERS IN THE FOLLOWING RANGE:

Loop Resistance R':	15.....150 Ohm/km
Inductance per unit length L':	0.4.....1 mH/km
Capacitance per unit length C':	80.....200 nF
C' = C' line/line + 0.5C' line/screen, if both lines are floating, or	
C' = C' line/line + C' line/screen, if the screen is connected to one line	less than or equal to 1000nF
Length of trunk cable:	less than or equal to 30m
Length of spur cable:	less than or equal to 1m
Length of spur splice:	

AT EACH END OF THE TRUNK CABLE AN APPROVED INFALLIBLE LINE TERMINATION WITH THE FOLLOWING PARAMETERS IS SUITABLE:

$$R = 90.....100 \text{ Ohm}$$

$$C = 0.....2.2 \text{ uF}$$

ONE OF THE ALLOWED TERMINATIONS MIGHT ALREADY BE INTEGRATED IN THE ASSOCIATED APPARATUS. THE NUMBER OF PASSIVE APPARATUS CONNECTED TO THE BUS SEGMENT IS NOT LIMITED DUE TO I.S. REASONS. IF THE ABOVE RULES ARE RESPECTED, UP TO A TOTAL LENGTH OF 1000 m (SUM OF TRUNK AND ALL SPUR CABLES) OF CABLE IS PERMITTED. THE INDUCTANCE AND THE CAPACITANCE OF THE CABLE WILL NOT IMPAIR THE INTRINSIC SAFETY OF THE INSTALLATION.

<b>EMERSON</b>		Emerson Process Management USA	
400 N. ZEEB RD. ANN ARBOR, MI 48106 482-1130 ext.4000 http://www.emerson.com	Process Solutions	SOLE AGENT	1998
00475-1130		4	4
C			



## APPENDIX C

## GRAPHICS INFORMATION

### OVERVIEW

The Graphics functionality enables new, graphical screens by using enhanced Electronic Device Description Language (EDDL) capabilities. You can now view HART or fieldbus device information as images, charts, and graphs.

To view the graphical representations, you need a device using an enhanced EDDL device description and a 475 Field Communicator. The following sections provide details on the window layout, the buttons used to modify the graphics, and the graphics options.

### SCREEN LAYOUT

A 475 Field Communicator has three elements on a window: a command bar, a tag bar, and buttons. The command bar shows the back arrow icon, HART heartbeat or fieldbus logo, LAS indicator (fieldbus devices only), ScratchPad application icon, and terminate icon. The tag bar shows the device type and device tag. The buttons let you modify the appearance of a window by panning, zooming, or resetting the window.

The **HELP** key appears if there is help associated with the particular selection. Use the left arrow button on the 475 Field Communicator or the back arrow icon on the window to close the view and return to the previous menu.

Figure C-1. 475 Field Communicator Screen Layout

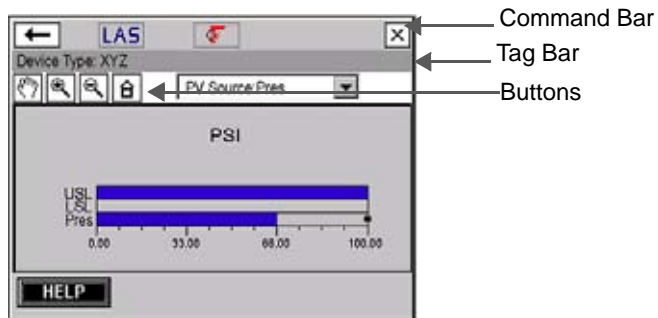

## BUTTONS

Use the following buttons to modify the appearance of the graphs and charts on your window:



Pan - Tap this button, select a point in the chart or graph, and drag to move it back and forth in the window.



Area zoom - Tap this button, then tap and drag a point in the chart to create an enlarged box. After you release your stylus from the window, the chart enlarges to fit the area. This control is available on strip charts and graphs only.



Zoom in - Tap this button to zoom in at a fixed rate from the center of the chart. Tap again to repeat the action.



Zoom out - Tap this button to zoom out at a fixed rate from the center of the chart. Tap again to repeat the action.



Reset - Tap this button to return the chart or graph to its original home view, removing any panning or zooming you have performed.



Drop-down list - Tap this menu to select between different variables to highlight on the chart or graph.

## GRAPHICS OPTIONS

### Images

An image is a full screen picture of a device. Images can include logos and various graphics, such as tanks. To view the image, select the image or drawing label in the menu. The full screen image is shown. To return to the menu view, press any key or tap the touch screen.

Figure C-2. Image Example





## Charts

Charts display a graphic view of variables as they occur over time. There are four major types of charts:

- Strip/sweep/scope - Displays variable data with an x-axis of time. A strip chart continually updates the chart, scrolling from right to left.

A scope/sweep chart paints the window from left to right, and then paints the window from left to right again, overwriting the oldest data. A vertical line is used to separate the old and new data. When the data reaches the right edge of the screen, the data is then plotted from the left edge of the screen and the x-axis is updated.

- Horizontal bar - Displays data represented as bars from left to right.
- Vertical bar - Displays data represented as bars from bottom to top.
- Gauge - Displays a gauge chart, similar to an analog car speedometer.

### NOTE

If a chart is displayed for an extended time period, the 475 Field Communicator will have decreased response time due to the large number of data points in the chart.

### Strip/Sweep/Scope Charts

The strip/sweep/scope chart formats device data into a line chart that displays device data over time. The labels and axis displayed are determined by the device manufacturer. Use the drop-down list to select the variable you want to highlight. The selected variable is displayed as a bold, solid colored line. Other variables that share the same source or same Y-axis appear as thin colored lines on the chart. Variables that do not share the same axis as the selected variable appear as dashed, colored lines. The colors displayed are determined by the device description and may vary between devices.

A vertical line may be displayed in the chart to distinguish between the old and new data. The vertical line advances as new data is displayed.

For the sweep and scope charts, the pan, zoom-in, zoom-out, and reset affect only the Y-axis.

The time shown on the x-axis starts at the time the chart starts. The chart update rate is determined by the device manufacturer. The default chart update rate is 1 second.

Figure C-3. Strip/Sweep/Scope Chart Example

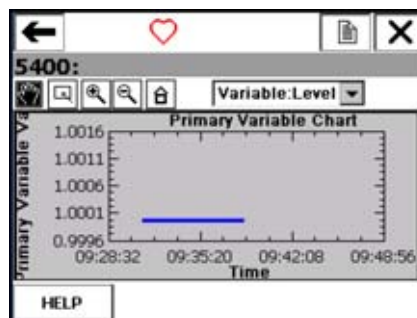

### Horizontal Bar Charts

A horizontal bar chart formats device data into bars from left to right and varies with time. Use the drop-down list to select the variable you want to highlight. Additional horizontal bars may be present if more than one variable is defined for the option you selected in the drop-down list. The selected variable from the drop-down list appears in color and has a black dot at the end of it. The colors displayed are determined by the device description and may vary between devices. The labels and axis displayed are determined by the device manufacturer.

The chart update rate is determined by the device manufacturer. The default chart update rate is 1 second.

Figure C-4. Horizontal Bar Chart Example

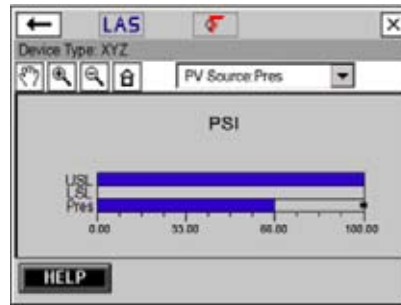

### Vertical Bar Charts

A vertical bar chart formats device data into bars from bottom to top and varies with time. Use the drop-down list to select the variable you want to highlight. Additional vertical bars may be present if more than one variable is defined for the option you selected in the drop-down menu. The selected variable from the drop-down list appears in color and has a black dot above it. The colors displayed are determined by the device description and may vary between devices. The labels and axis displayed are determined by the device manufacturer.

The chart update rate is determined by the device manufacturer. The default chart update rate is 1 second.

Figure C-5. Vertical Bar Chart Example

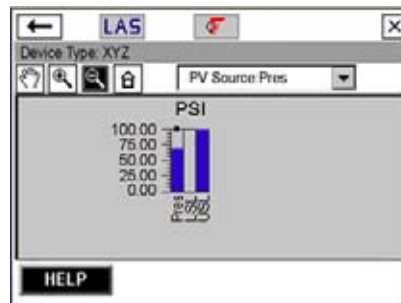

### Gauge Charts

A gauge chart formats device data into a view similar to an analog car speedometer and plots device data varying with time. Use the drop-down list to select the variable you want to highlight. Additional gauge needles may be present if more than one variable is defined for the option selected in the drop-down list. The selected variable from the drop-down list appears as a long, colored needle while the other variables appear as short, colored needles. The colors displayed are determined by the device description and may vary between devices. There can only be a maximum number of three variables per gauge chart. The labels and axis displayed are determined by the device manufacturer.

The chart update rate is determined by the device manufacturer. The default chart update rate is 1 second.

Figure C-6. Gauge Chart Example

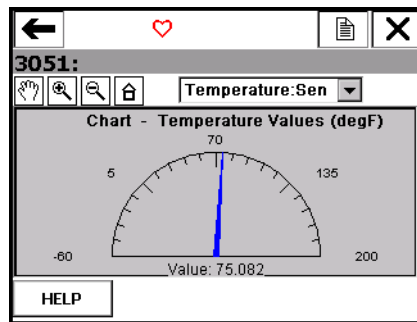

### Graphs

A graph is a snapshot line drawing of device information. Use the drop-down list to select the variable you want to highlight. Additional variables may be present if more than one is defined for the option selected in the drop-down list. The selected variable from the drop-down list appears as a bold, solid colored line while the other variables with the same Y-axis appear as thin colored lines. The colors displayed are determined by the device description and may vary between devices. Variables that do not share the same Y-axis as the selected variable appear as dashed, colored lines. The labels and axis displayed are determined by the device manufacturer.

Figure C-7. Graph Example

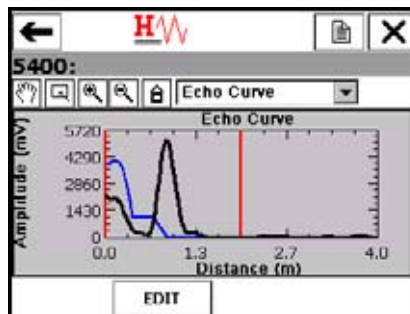



## GLOSSARY

### **Alphanumeric**

A character set that contains both letters and digits and, usually, other characters, such as punctuation marks.

### **AMS Suite: Intelligent Device Manager**

Software for remotely managing Smart devices (offline or online) over existing HART or FOUNDATION fieldbus networks. You can use AMS Device Manager to monitor devices, configure devices, maintain calibration results, run diagnostic routines, and maintain historical data.

### **Bluetooth**

Bluetooth is a wireless protocol for exchanging data. On the 475 Field Communicator, Bluetooth is a licensed feature that enables wireless communication between the 475 and a PC.

### **Burst Mode**

A communication mode in a HART transmitter to send data at regular intervals.

### **Card Reader**

A device that is capable of reading the System Card. You can use an approved card reader to transfer system software and device descriptions from the Field Communicator Easy Upgrade Utility to a 475 Field Communicator. See [www.fieldcommunicator.com](http://www.fieldcommunicator.com) or the readme file for a list of supported card readers.

### **CDC**

Communication and Diagnostic Circuitry. You can view the CDC version by double-tapping **Settings | About Field Communicator** from the Field Communicator Main Menu.

### **Data Link Time**

Data Link Time is a network-wide time periodically distributed by the LAS to synchronize all device clocks on the bus.

### **Device**

See HART device or fieldbus device.

### **Device Configuration**

Parameters that define the physical attributes and operating characteristics of a device. It does not include dynamic data.

### **Device Configuration Management**

A licensed feature that lets you save up to 1000 HART device or user configurations, depending on file size, to a System Card. It also lets you print and back up (save) the configurations using the Field Communicator Easy Upgrade Utility.

### **Device Description (DD)**

A set of instructions written in the HART or FOUNDATION fieldbus Device Description Language that defines the parameters, commands, and methods that a host application uses to communicate with a HART or FOUNDATION fieldbus device.

---

**Device menu**

A menu used by some FOUNDATION fieldbus devices, depending on their device descriptions (cross-block DDs). A device menu displays the same parameters as the Block List, but the parameters in a device menu are organized by function rather than by block.

**DDL**

Device Description Language. A specialized programming language used to write device descriptions for HART or FOUNDATION fieldbus-compatible devices. See *also* Device Description.

**Easy Upgrade option**

A licensed feature that lets you use the Field Communicator Easy Upgrade Utility to update the system software and DDs in your 475 Field Communicator. See your sales representative or the Online Licensing feature in the Easy Upgrade Utility for more information on purchasing this license.

**EDDL**

Electronic Device Description Language. Enhancements to the EDDL language enable device information to be displayed as images, charts, and graphs.

**Event Capture file**

An ASCII file (.rec file) that captures your keystrokes, display windows, and protocol communication messages on a 475 Field Communicator. Event Capture files can be useful in diagnosing problems. To create Event Capture files on a 475, you must enable the Event Capture function from the Settings menu.

**Fieldbus device**

A device that communicates information using the fieldbus protocol on a digital, serial, multidrop data bus.

**Fieldbus Foundation**

The organization that develops and supports FOUNDATION fieldbus, an international, interoperable standard for communication of process automation and control information. Members include suppliers and end users of process control and manufacturing automation products. Support for the standard includes education, interoperability and conformance testing, testing tools, and development software.

**FOUNDATION fieldbus**

A specific fieldbus technology developed and supported by Emerson Process Management and the other members of the independent Fieldbus Foundation. FOUNDATION fieldbus technology uses device descriptions and function blocks to enable intelligent devices to execute control functions traditionally performed by a distributed control system.

**Graphics**

A feature that enables the 475 Field Communicator to display device information as images, charts, and graphs by using enhanced Electronic Device Description Language, EDDL. To view the graphical representations, you need a device using an enhanced EDDL device description.

**HART device**

A device that communicates information using the HART protocol.

**HART loop**

A communication network in which the master and slave device are HART-smart or HART-compatible.

**HART protocol**

Highway Addressable Remote Transducer communication protocol. An industry-standard protocol for digitally enhanced 4-20 mA communication with Smart devices.

**HART tag**

An 8-character field used to identify a device. A 32-character long tag is also possible with HART revision 6 or higher devices. This field is stored in the HART device and can be modified.

**Instantiation**

Some FOUNDATION fieldbus devices support instantiation of function or transducer blocks in the device. This means the device allows a command to be sent to it that will create (instantiate) additional function or transducer blocks in the device. After instantiation, these blocks operate like any other block in the device. The 475 Field Communicator supports the commands to instantiate and to delete function and transducer blocks in a fieldbus device.

**Internal Flash**

Non-volatile memory that stores the operating system, application software, internal device configurations, Event Captures, fieldbus statistics, and user generated text files.

**Intrinsic Safety (IS)**

Circuits that are designed to limit the amount of energy consumed or provided to devices to levels below those that are required to ignite specific types of hazardous materials under fault and no fault conditions.

Also a method of providing safe operation of electronic process-control instrumentation in hazardous areas, such as flammable environments. IS systems keep the available electrical energy in the system low enough that ignition of the hazardous atmosphere cannot occur.

**Intrinsic Safety barrier**

A physical entity that limits the current and voltage into a hazardous area in order to satisfy Intrinsic Safety requirements.

**IrDA**

Infrared Data Association, a non-profit trade association that establishes standards for infrared communications between devices such as personal computers, printers, and handheld devices.

The 475 Field Communicator can use an IrDA adapter to communicate with the Field Communicator Easy Upgrade Utility or AMS Device Manager.

**Lead Set**

A cable with two 4mm banana plugs used to connect to a device.

**Link Active Scheduler (LAS)**

The bus arbiter for the segment. The LAS recognizes and adds new devices to the link, removes non-responsive devices from the link, and distributes Data Link (DL) and Link Scheduling (LS) time on the link.

**Link Master**

A Link Master device controls when devices access the fieldbus and executes the link schedule, which synchronizes communications with function block execution on the fieldbus. The H1 card or any device that supports Link Master functionality can function as a Link Master device. Only one Link Master device can be active at a time on the fieldbus segment. This device is called the LAS.

**Link Scheduling time**

Link Scheduling time is a link-specific time represented as an offset from Data Link Time. It is used to indicate when the LAS on each link begins and repeats its schedule. System management uses it to synchronize function block execution with the data transfers scheduled by the LAS.

**Lithium Ion Power Module**

A Lithium Ion (Li-Ion) battery used to power the 475 Field Communicator. The battery has a green, 6-pin power supply/charger connector. See Figure 2-1 on page 2-3 for the location of this connector. The battery must be charged by the Field Communicator power supply/charger with the matching green connector.

**Online Licensing**

A feature in the Field Communicator Easy Upgrade Utility to select and download new licenses that enable additional functionality in the 475 Field Communicator. You can order and download licenses for Easy Upgrade and FOUNDATION fieldbus application. The 475 Field Communicator must be licensed for the Easy Upgrade option before you can download a license for the FOUNDATION fieldbus application. See the Easy Upgrade Utility Help for more information.

**Personal Computer (PC)**

Synonymous with microcomputer, a computer that serves one user in the office or the home.

**Polling**

A method of sequentially interrogating a network to determine which devices are present.

**Process variable (PV)**

A process parameter that is being measured or controlled (for example, level, flow, temperature, mass, or density).

**Resource CD**

A CD included with the purchase of a 475 Field Communicator. It contains electronic copies of product documentation, the install file for the Easy Upgrade Utility, and the latest system software and device descriptions at the time the CD was created.

**Segment (Fieldbus only)**

The section of a fieldbus that is terminated in its characteristic impedance. Segments are linked by repeaters to form a complete Fieldbus.

**Shout/deaf mode**

A communication mode in the 475 Field Communicator where the amplitude of the 475 signal is increased. The 475 Field Communicator determines when to enter this mode. The  icon (with a solid or hollow heart) indicates when the 475 Field Communicator is in this mode.



**Standby**

A power option that turns off the screen display and parts of the 475 Field Communicator. Use this feature to save battery life or to reduce the boot-up time. The green light on the Power key slowly flashes to indicate the 475 Field Communicator is in standby mode.

**System Card**

An internal Secure Digital Card with non-volatile Flash memory. A copy of installable 475 Field Communicator application software exists on every System Card. The System Card also stores HART device configurations and all HART and FOUNDATION fieldbus device descriptions.

**System Card Serial Number (S/N)**

The serial number assigned by the manufacturer to a Secure Digital (SD) card. The System Card Serial Number uniquely identifies a 475 Field Communicator System Card.

**User Configuration**

A configuration that is created offline or that is transferred to a 475 Field Communicator from another program. Editing a device configuration within the 475 Field Communicator will change it to a user configuration.

**User data file**

A text (.TXT) file created by a user either on a PC or with the ScratchPad application on the 475 Field Communicator. User data files can be transferred between the Field Communicator Easy Upgrade Utility and a 475.

**WirelessHART adapter**

A HART device that meets the WirelessHART standard and enables a wired HART device to join a Wireless network and communicate with the gateway.

**WirelessHART device**

A digital HART device that meets the HART 7 WirelessHART standard and has been enhanced with wireless capability to function within a Wireless network. This device is not connected to a 4-20mA loop.



## INDEX

### Symbols

.hcf files 2-16, 3-6  
.rec files 2-15, G-ii  
.txt files 2-21, G-v

### A

About Field Communicator 2-12  
Advanced features 4-14  
Alphanumeric keypad 2-8, A-1  
AMS Device Manager  
    Communicate with 2-16  
    Definition G-i  
    System Card does not appear 3-6  
Analog output 3-9  
Approval drawing B-6  
Asterisk 3-3, 3-4, 3-11, 4-11, 4-13  
ATEX B-2  
Auto-off timer  
    Disabled 2-12, 2-14, 2-17, 2-21  
    Enable 2-14

### B

Back arrow 2-7  
Backlight  
    Adjust 2-12  
    Intensity 2-14  
    Key 2-8, 2-12  
    Setting 2-14  
    Timer 2-12, 2-14  
Basic Setup menu 3-11  
Battery  
    Charge 2-3, 2-4  
    Conserve power 2-12, 2-14  
    Labels B-4  
    Lights 2-3, A-3  
    Operating time A-2, A-3  
    Reduced life 2-8, 2-14  
    Remove 2-11  
    Storage guidelines A-3  
    Usage guidelines 2-3  
Bench wiring  
    Fieldbus device 4-5  
    HART device 3-7  
Block  
    Delete 4-15  
    Device 4-11  
    Instantiate 4-14  
    List 4-8  
Bluetooth  
    Certification B-1, B-2  
    Connect 2-18  
    Definition G-i  
    Overview 2-18  
    Symbol on keypad 2-6, 2-18  
    View license 2-13  
Brightness, see Backlight  
    2-12

Burst Mode 3-10, G-i

### C

Canadian Standards Association B-3  
Card Reader G-i  
    Connect 2-19  
    Supported 2-19  
CE Compliance B-2  
Certifications B-1, B-2, B-3  
Charts C-3  
Clock 2-13  
Communication and Diagnostic Circuitry 2-12, G-i  
Communication terminals 2-6  
Configuration  
    Device 3-3, G-i  
    Limited number in Internal Flash 2-8  
    Limited number in System Card 2-8, G-i  
    Management license G-i  
    Offline 3-3, 3-4  
    Online 3-10  
    Opening 3-4  
    Partial 3-3  
    Sending to a device 3-5  
    Sort 3-4  
    Transferring between a PC 3-6  
    User 3-3, G-v  
Configure  
    Fieldbus Application 4-16  
    HART Application 3-13  
Connecting  
    250-ohm resistor 3-8  
    Fieldbus device 4-5  
    Fieldbus segment 4-6  
    HART device 3-7  
    HART loop 3-6  
    Load resistor 3-8  
Contrast 2-13

### D

D/A trim 3-11  
Damping 3-11, 3-13  
Data Link Time G-i  
Date/Time 2-13  
DDL G-ii  
DeltaV System Polling checkbox 4-16  
Detail 4-13  
Detailed Setup 3-12  
Device  
    Address 4-13  
    Blocks 4-11  
    Configuration G-i  
    ID 4-13  
    Revision 4-13  
    Setup 3-11  
    Status 4-12  
    Tag 3-11, 4-13

- Test 2-2, 3-11
- Device Configuration Management G-i
- Device Description
  - Add new 2-19
  - Definition G-i
  - Icons 3-17, 4-16
  - Incompatible 3-17
  - Installed 3-17, 4-16
  - Storage 2-8
  - Tested 3-17
  - Untested 3-17
- Diagnostics
  - And Service 3-11
  - Fieldbus 4-17
  - HART 3-18
- Disconnecting
  - Fieldbus device 4-18
  - HART device 3-18
- Display, see Touch screen
- Disposal 2-23

**E**

- Easy Upgrade license G-ii
  - Renew 2-20
  - View expiration date 2-13
- Easy Upgrade Utility
  - Connection types 2-17
  - Install 2-16
  - Overview 2-16
  - Upgrade Field Communicator 2-19
- EDDL 3-12, 4-15, G-ii
- Edit HART configurations offline 3-4
- Electro Magnetic Compatibility B-2
- Enclosure rating A-1
- Enter key 2-7
- Environmental specifications A-5
- Error messages 5-5
- European directive information B-2
- Event Capture 2-15, G-ii, G-iii

**F**

- Factory Mutual B-3
- Fast key 3-2
- FCC B-1
- Field Communicator Main Menu 2-11
- Fieldbus 2-12
  - Bench wiring 4-5
  - Connecting 4-4
  - Diagnostics 4-17
  - Field wiring 4-6
  - Foundation G-ii
  - Functionality 4-1, 4-2
  - Online 4-4
  - Starting the application 4-3
  - Terminals 4-4
  - Utility menu 4-16
- Filter
  - Sort 3-4
  - Tag 3-4
- FILTR button 3-4
- Flash, see Internal Flash 2-8
- Fn Key, see Function Key 2-8
- Foundation fieldbus
  - Application 4-1

- Definition G-ii

- Function
  - Blocks 4-11
  - Key 2-6, 2-8

**G**

- Gauge chart C-5
- Graphics G-ii
  - Buttons C-2
  - Controls C-2
  - Enhanced DDs 3-12, 4-15
  - Fieldbus devices 4-15
  - HART devices 3-12
  - License 3-12
  - Options C-2
  - Overview C-1
- Graphs C-5

**H**

- HART 2-12
  - Device G-ii
  - Diagnostics 3-18
  - Functionality 3-1
  - Icon 3-10
  - Long tag 3-16
  - Loop 3-6, 3-7, 5-1, G-ii
  - Main menu 3-2
  - Offline menu 3-3
  - Polling options 3-15
  - Protocol G-iii
  - Short tag 3-16
  - Simulation 3-17
  - Starting Application 3-2
  - Tag G-iii
  - Terminals 3-6, 3-7
  - Utility menu 3-13
  - Wiring 3-7
- Hazardous Locations Certifications
  - ATEX B-2
  - CSA B-3
  - FM B-3
  - IECEX B-3
- HOME 3-9
- Horizontal bar chart C-4
- Hosts 4-13, 4-14
- Hot Key
  - Removing 3-14, 3-16
  - Setting Up 3-13

**I**

- I/O block schedule 4-14
- IECEX B-3
- Ignored status messages 3-16
- Images C-2
- Instantiate blocks 4-14, G-iii
- Internal Flash 3-16, A-1, G-iii
- Intrinsic Safety G-iii
- IrDA
  - Adapter 2-18
  - Association G-iii
  - Overview 2-18

**K**

- Keypad, See also Alphanumeric keypad
- KL option A-5

**L**

Label  
 Battery B-4  
 Drawings B-3  
 Intrinsic Safety B-4  
 RoHS B-5  
 WEEE B-5  
 License  
 Add new 2-20  
 Available 2-13  
 View existing 2-13, 2-20  
 Lights  
 Battery 2-3  
 Power supply/charger 2-5  
 Link Active Scheduler 4-2, 4-7, G-iii  
 Link Master devices 4-2, G-iv  
 Link Scheduling time G-iv  
 Listen For PC 2-7, 2-17  
 Load resistor 3-8  
 Long tag 3-16  
 Loop  
 HART G-ii  
 Terminals 3-6  
 Test 3-11  
 Troubleshooting 5-1  
 Lower range value 3-9

**M**

Maintenance 2-23  
 Manufacturing locations B-1  
 Maximize Power Savings 2-14  
 Memory A-1  
 Specifications A-1  
 Types 2-8  
 View free space 2-13  
 Menu  
 Block 4-11  
 Fieldbus Diagnostics 4-17  
 Fieldbus Main 4-3, 4-16  
 Fieldbus Online 4-4, 4-15  
 Fieldbus Utility 4-3, 4-16  
 HART Diagnostics 3-18  
 HART Offline 3-3, 3-4  
 HART Online 3-9, 3-12  
 HART Utility 3-14, 3-15, 3-16, 3-17  
 Hot Key 3-13  
 Title 3-16  
 Messages  
 Error 5-5  
 Ignored Status 3-16  
 Safety 2-1, 3-1, 4-1  
 Status 5-5  
 Methods 4-12  
 Microprocessor A-1  
 Modes 4-9  
 Actual 4-10  
 Block 4-11  
 Burst 3-10, G-i  
 Change 4-10  
 MAN 4-11  
 Out of Service 4-11  
 Parameters 4-9  
 Shout/deaf 3-10, G-iv  
 Target 4-10

Types 4-9

**N**

Navigation keys 2-7

**O**

Online 3-6  
 Fieldbus menu 4-4, 4-7  
 HART menu 3-9  
 Licensing G-iv  
 Operating system 2-12  
 Ordering information A-5  
 Output trim 3-12

**P**

Parameters  
 Changing and sending data 4-11  
 Displaying blocks 4-11  
 Functionality 4-11  
 Modes 4-9  
 Personal computer A-2, G-iv  
 Physical device tag 4-13  
 Physical specifications A-1  
 Polarity 4-4  
 Polling 3-15, 4-16, G-iv  
 Power key  
 Disabled 2-17, 2-21  
 Functionality 2-7  
 Turn on 475 2-11  
 Power Management Timers 2-14  
 Power Module  
 Definition G-iv  
 See Battery  
 Power Status 2-14  
 Power supply/charger  
 Guidelines 2-3  
 Lights 2-5  
 Specifications A-3  
 Voltage A-3  
 Primary variable 3-9  
 Process variables 3-11, G-iv  
 Processor specifications A-1  
 Product Precautions 2-1  
 Protocol  
 Fieldbus G-ii  
 HART G-iii

**R**

R&TTE B-2  
 RAM 2-8, A-1  
 Range values 3-11  
 Reference A-1  
 Re-Flash 2-12  
 Re-Image 2-12  
 Repair 2-23  
 Resistance  
 Troubleshooting 5-1  
 Retrain The Battery 2-14  
 Review menu 3-12  
 RoHS B-5

**S**

Safety messages 2-1, 3-1, 4-1  
 Saving  
 Online configuration 3-10

- Text 2-22
  - Scaled D/A trim 3-11
  - Schedule I/O Block 4-14
  - Scope chart C-3
  - ScratchPad
    - Application 2-7
    - New 2-21
    - Opening 2-21
    - Saving text 2-22
  - Screen. See Touch Screen 2-14
  - Segment G-iv
  - Self test 2-23
  - Sensor setup 3-12
  - Sensor trim 3-11, 3-12
  - Settings
    - About Field Communicator 2-12
    - Backlight 2-12
    - Clock 2-13
    - Contrast 2-13
    - Event capture 2-15
    - License 2-13
    - Memory 2-13
    - Power Status 2-14
    - Retrain The Battery 2-14
    - Touch screen 2-14
  - Short tag 3-16
  - Shout/deaf mode 3-10, G-iv
  - Shut-down timer. See Auto-off timer
  - Shutting down 2-11, 2-12
  - Simulation 3-17
  - Soft Input Panel (SIP) 2-7
  - Specifications A-1–A-5
  - ST\_REV 4-3
  - Standby
    - Definition G-v
    - Enter/Leave 2-12
    - Mode 2-7, 2-12, 2-14
    - Timer 2-12, 2-14, 2-17, 2-21
  - Status
    - Device 4-12
    - Messages 5-5
    - Number of Ignored 3-16
  - Storage 2-8
    - Cleanup 3-16
    - Guidelines A-1, A-3
  - Strip chart C-3
  - Stylus
    - Location 2-6
    - Using 2-7
  - Sweep chart C-3
  - System Card
    - Connect with card reader 2-19
    - Definition G-v
    - Does not appear in AMS Device Manager 3-6
    - Install 2-5
    - Remove 2-11
    - Serial Number 2-13, G-v
    - Specifications A-1
  - System Software
    - Add new 2-19
    - Version 2-1, 2-11
- T**
- Tab key 2-8
- Tag**
- Access 3-11
  - Alphanumeric 3-11
  - Device 3-13, 4-13, C-1
  - Filter 3-4
  - HART G-iii
  - Polling 3-15
  - Temperature A-1
  - Terminals 2-6, 3-6, 4-4, A-2
  - Terminate button 2-7
- Test**
- Device 2-2, 3-11
  - Loop 3-11
  - Self 2-23
- Time/Date 2-13**
- Timers**
- Auto-off 2-12, 2-14, 2-17, 2-21
  - Backlight 2-12, 2-14
  - Standby 2-12, 2-17, 2-21
- Touch screen**
- Alignment 2-14
  - Layout C-1
  - Specifications A-1
  - Using 2-7
- Trim**
- D/A 3-11
  - Scaled D/A 3-11
  - Sensor 3-11
- Troubleshooting 5-1**
- U**
- Unit Name**
- Assign 2-16
  - View 2-13
- Untested Device Description 2-2**
- Upper range value 3-9**
- User Configuration 3-3, G-v**
- User data file G-v**
- Utility menu**
- Fieldbus 4-3, 4-16
  - HART 3-2, 3-13, 3-14, 3-16, 3-17
- V**
- V(FUN) 4-16**
- V(NUN) 4-16**
- Vertical Bar chart C-4**
- Voltage 3-18, 4-3**
- Troubleshooting 5-2
- W**
- Waste Disposal 2-23**
- WEEE B-5**
- Weight A-1**
- WirelessHART adapter 3-15, G-v**
- WirelessHART device G-v**
- Wiring**
- Fieldbus 4-5, 4-6
  - HART 3-7
  - Troubleshooting 5-3
- X**
- XPAND button 3-4